

**NATIONAL PARK SERVICE
CAMPGROUND DEVELOPMENT GUIDELINES**

External Review Draft – September 30, 2020

This page intentionally left blank.

INTRODUCTION

USING THE GUIDE

The development guidelines included within this document are intended to promote a consistent approach to campground changes and improvements. Users include all National Park Service staff and private contractors including planners, designers, superintendents, maintenance staff, concessioners and partners. The information is designed to assist all sizes and scopes of projects related to campgrounds and consequently some of the information is general in nature while other information is more detailed.

The document is broken up into sections to lead users through a common project sequence; however, the guide can be used at any point in a project or maintenance effort. Use the table of contents to quickly navigate to the desired section. Throughout the guide you will also find quick links to related sections to assist with navigation.

DOCUMENT OBJECTIVE

The National Park Service Second Century Campground Design Guidelines offer a consistent approach towards campground design and construction efforts across the service. “From its earliest days, the National Park Service has relied on shared standards to ensure that its services and facilities are appropriate, consistent, and of good quality.”¹ Specifically, the guide provides users with information regarding planning, design, maintenance and operations. The inclusion of specific service processes will assist park managers, contractors and concessioners to make thoughtful design decisions that meet the needs of their campground, while complying with overall National Park Service requirements. The guidelines are intended for the National Park Service; however, other state and federal land management agencies may also find it useful and relevant.

National Park Service facility improvements strive to find balance in resource protection and visitor enjoyment. These two principles can often conflict; however, with proper planning and consideration, a balanced approach can be developed—one that allows the National Park Service to maintain relevancy with its visitors by modernizing and adapting while minimizing or mitigating impacts to resources.

Campgrounds within the National Park Service are diverse and reach from coast to coast in a number of different climates and contexts. They offer visitors many unique ways to stay overnight within the national park system. Just as each campground is unique, so is the approach to design and maintenance. The information within this document is intended to serve as a guide with the understanding that no one size fits all and each site will have its own unique requirements. As a government agency, the National Park Service is mandated to follow federal legal requirements. Legal requirements are identified as such throughout the guide.

1. https://www.nps.gov/policy/DOrders/DO_52C.pdf



To conserve the scenery and the natural and historic objects and the wild life therein and to provide for the enjoyment of the same in such manner and by such means as will leave them unimpaired for the enjoyment of future generations. Organic Act (39 Stat. 535, 16 U.S.C. 1)

Figure I-1 Joshua Tree National Park, Ryan Campground

This guide is intended to reduce research requirements for common campground design elements and provide guidance that is pertinent to the National Park Service by compiling relevant and current information in one location. The guide includes considerations for current and future visitor needs and expectations. It also promotes inclusion of a diversity of user groups and recreation opportunities through universal design principles and goals. The goal of each park is that every user regardless of their ability and background is welcomed and included in a modern National Park Service campground.

CONTENTS

Chapter One: National Park Service Campground History	1
Pre-1930s: Early Campgrounds	1
1930s: Rustic Campgrounds.....	4
1950s – 1960s: Mission 66 and Campgrounds	6
Conclusion.....	8
Brief Timeline.....	10
Chapter Two: Scoping, Compliance, and Design.....	13
Project Scoping Considerations	13
Understanding the Visitor	13
Accessibility	15
Inclusivity.....	16
Investment and Management Tools	16
Concessions.....	17
Baseline Documentation – Cultural	17
Site Analysis	18
Design Considerations.....	19
Permitting	20
Planning	21
Pets in Campgrounds	21
Compliance Considerations.....	21
National Environmental Policy Act	21
National Historic Preservation Act and Section 106	22
Wilderness	23
Threatened and Endangered Species Act	23
Wetlands and Floodplains.....	24
Additional Compliance Resources.....	24
Tribal Consultation Policy	25
Universal Design and Accessibility	25
Other NPS Specific Issues	25
Design Process	25
Site Development.....	26
Defining Site Development	26
Low-Impact Development.....	27

Restoration	27
Chapter Three: Campground Design Guidelines.....	29
Arriving at the Campground	29
Vehicular Arrival.....	34
Alternate Arrival Considerations.....	35
Bus and Ride Share Drop-Off	35
Bicycle Facilities.....	37
Signage.....	39
Regulatory Signage and Pavement Markings.....	40
Pavement Markings.....	41
Other Signs	42
Emergency Management or Warning Signs.....	43
Motorist Guidance and Pedestrian Wayfinding	44
Motorist Guidance	44
Pedestrian Wayfinding.....	45
Campsite Loops	46
Informational Signs	47
Check-in Procedure and General Campground Rules	47
Trailhead Examples.....	48
Recycling Signs.....	51
Campground Access: Roads, Routes, and Trails.....	52
Roadways and Trails	52
Collector (Primary Campground) Roadways.....	57
Local (Secondary Campground) Roadways	58
Adapting Existing Narrow Roadways	58
Vehicle Barriers for Roadway Definition	60
Campground Parking.....	64
Connector Routes and Trails.....	65
Hiking and Horse Trails	66
Social Trails	66
Campground Layouts	66
Layout Design Considerations	67
Vegetation.....	67
Roads and Trails	67
Topography	68

Viewsheds.....	68
Campsites.....	68
Buildings and Structures.....	69
Fire Protection.....	69
Campsite Distribution in a Campground.....	69
Campsite Layouts.....	70
Campsite Types.....	72
Vehicle and Tent.....	72
Large RV and Trailers with Pop Outs.....	75
Bicycle/Backpacker Sites/Walk-in Sites.....	77
Equestrian Campsites.....	78
Recreational Boating Campgrounds.....	80
Raised Platform Sites.....	82
Group Campsites.....	84
Cabins, Fixed Walled Tents, Glamping, and Concession Lodging.....	84
Backcountry Sites and Dispersed Camping.....	86
Special Use Sites.....	87
Campground Services.....	88
Determining Facility Capacities.....	89
Estimating Water and Wastewater Capacity.....	90
Water.....	91
Water System Design Process.....	92
Water Hydrants.....	93
RV Water.....	97
Wastewater.....	98
Wastewater System Design Process.....	99
RV Wastewater.....	100
Comfort Stations.....	101
Ratios and Distances.....	102
Materials.....	103
Accessibility.....	104
Sustainability.....	107
Flush Toilets.....	107
Mission 66 Comfort Stations.....	108
Vault Toilets.....	110

Dishwashing Stations	115
Electrical Services	116
Lighting	119
Indoor Lighting.....	119
Outdoor Lighting.....	120
Best Practices for Preserving Dark Night Skies	120
Telecommunications.....	122
Amphitheater.....	123
Siting.....	123
Materials and Details	125
Solid Waste and Recycling Management	127
Leave No Trace Study, 2019	127
Green Waste and Waste Reduction Considerations	128
Picnic Table at Campsite.....	130
Materials	131
Design Considerations.....	131
Picnic Areas (Stand Alone)	132
Distance and Ratios.....	133
Group Picnic Sites	133
Fire Pits and Grills	135
Specifications	135
Design Considerations.....	137
Bear Boxes / Food Lockers.....	138
Hammock Hangers.....	140
Light Posts / Lantern Hangers	140
Expanded Campground Services	141
Showers.....	141
Distance and Ratios.....	141
Design Considerations.....	141
Dump Stations.....	145
Distances and Ratios	145
Laundry.....	147
Car Charging Stations	148
Chapter Four: Operations and Maintenance.....	149
Appendixes	151

Appendix A: References.....153
Appendix B: Historical Campground Timeline.....157

This page intentionally left blank.

CHAPTER ONE: NATIONAL PARK SERVICE CAMPGROUND HISTORY

As Albert Good wrote of organized camping, it “is either very old or relatively very new, depending on the perspective in which its background is seen” (Good 1938). It was, in fact, a camping trip that inspired a deeper look at the potential of the national park concept. In May 1903, President Theodore Roosevelt camped in Yosemite with the legendary John Muir. Following that trip, President Roosevelt set aside 18 National Monuments, 55 bird sanctuaries and game preserves, and added 148 million acres to the National Forest. Campground design, as guided by the National Park Service (NPS) throughout the twentieth century, evolved from a primarily rural and simplistic travel necessity to a concept and set of practices culminating in a designed typology within park landscapes. This evolution was multi-faceted with the National Park Service, incorporating design theory and building on a set of practical guidelines and applications for campground design. This body of knowledge responded to rapid changes in transportation technology—from train, to automobile, to camper trailer—that substantially increased and diversified park visitation while restraining and refining campground infrastructure to not only protect key park resources but also enhance visitor experience. Campground design, as such and throughout its history, follows the dual mission of the National Park Service. The importance of campgrounds within national parks cannot be understated as these are the places that primarily provide visitors an unparalleled opportunity to experience park environments. As we launch into the second century of NPS development, the relevancy of our nations campgrounds remains significant. In fact, in a world where more Americans are looking for ways to disconnect with their everyday lives and reconnect with the outdoors, these campgrounds are just as relevant today as they were to early twentieth-century campers.

PRE-1930S: EARLY CAMPGROUNDS

In the early years of the agency, national parks had few campgrounds as the earliest travelers primarily used train travel constructed in conjunction with national park development to reach their destinations. As use of the automobile developed following World War I, campground construction followed that of similar roadside camps across the country, increasing in space and frequency with the development of roads.

These campgrounds had minimal site planning, seeking a location with relatively level topography, access to water, and proximity to roadways. The form of earliest campgrounds, if constructed at all, could be likened to a tadpole and included a single gravel road (the “tail”) terminating in a loop (the “head”). The road was 12 – 18 feet wide, requiring vehicles to pull-over to let others pass. Campsites were informal, undeveloped, and often un-delineated. Drivers could parallel park beside the road or pull off further into the camp area. Campers placed tent shelters along either side of the camp road, in the area circumscribed by the loop road, or radiating out from the loop road. Pit toilets were often located within the center of the loop and or near the road (Dolan 2020).

Generally, no other services were provided. The consequences of the lack of early campground design included over-use, unsanitary conditions, impacts to soils, denuded vegetation, and tree harvesting (Dolan 2020). To directly respond to these issues, the National Park Service began to develop overall guidance and solutions to site problems. Two key concepts arose to guide a cohesive style of planning for campgrounds and early park infrastructure: the landscape should be preserved (minimize damage to the vegetation and site) and construction should harmonize with nature (blend into the landscape and preserve important viewsheds) (McClelland 1998). These tenants grew from the English garden tradition of the picturesque and could be seen in practice through the work of Downing, Olmsted, and Eliot, among others.

The appointments of the first landscape engineers were critical in campground development. In 1914, the Secretary of the Interior appointed Mark Daniels as superintendent of Yosemite National Park and landscape engineer to parks. Daniels created a three-tiered development approach for accommodation, presented at the 1915 National Park Conference in San Francisco. Daniels' recommendations included permanent camps with access to food from dining halls and tent camping, where visitors could prepare their own meals. He also devised key components of the park village concept that included roads, lodges, campgrounds, dining halls, camp stores, gas stations, and other associated infrastructure setting the groundwork for a more comprehensive look at park development that would guide NPS standards in the coming decades (McClelland 1998). In response to increased automobile travel during the post war years, Stephen Mather also envisioned a system of highways connecting larger western national parks with free automobile camps as funding allowed, again with basic services such as water, cooking areas, and basic toilet facilities (McClelland 1998). Mather's forethought for park road connectivity and the importance of accommodation for all levels of park visitor illustrates the importance of the campground as an early component in park design.



Figure 1.1 Camping near monument - Wakefield, Virginia. Circa 1924. George Washington Birthplace National Monument. NPS Museum Number Catalog : HFCA 1174. Photo Credit: Ezra B. Thompson. Note campsite does not have delineation, and camping under young trees would negatively impact trees through soil compaction.

Following Daniels, Charles Punchard was appointed as the first landscape engineer for the National Park Service. Punchard's time was short, running from just 1918 until his death in 1920. However, he was effective in creating a vision to move the National Park Service forward in design and planning, spending a great deal of time on campground design. Building on the ideas of Daniels, Punchard worked on "developmental schemes" for overall park development (McClelland 1998). This work included placement and clustering of buildings, support for and review of concessioner's plans and

designs, and the notation of critical elements and key scenic qualities that should be preserved in park landscapes. Key elements included natural topography and drainage, important trees, and other natural features such as rock outcroppings (McClelland 1998).

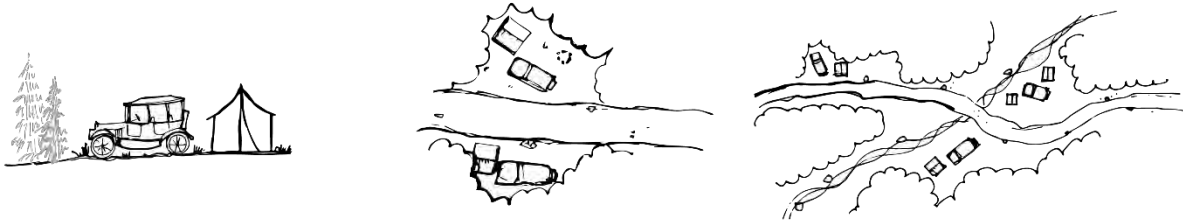

Figure 1.2 1910s. There were no official NPS campgrounds in the 1910s, as between 1916 and 1920 there were no congressional appropriations for park infrastructure. With no formalized camping areas, visitors camped in flat areas. Serious vegetation damage and water quality issues resulted from unformalized camping.

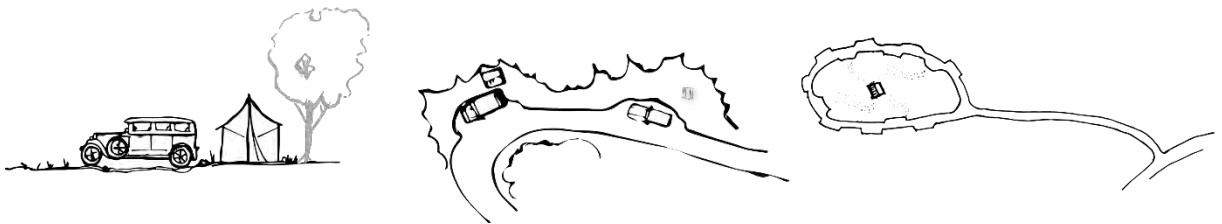

Figure 1.3 1920s. Small formalized campgrounds began. These included small vehicle bump-outs with fire ring and cooking surface, drinking water hydrant, and pit toilets provided. Picnic tables were sometimes provided.

Campground development followed as part of a larger comprehensive approach to park design, with Punchard focused on developing permanent campgrounds and rehabilitating existing camping areas. By 1919, he created the basic standards for NPS campgrounds to be carried forward: access to a drinking water supply, sanitary toilet facilities, screening from park roads, and areas for roadways, parking, and living space. Living spaces included an established cooking area to reduce fire hazards, tables, and seating. Further, Punchard encouraged the concept of a campground community building containing bathing and laundry facilities and, for larger campground operations, camp stores and even post offices. The community building would not only contain basic services but would become the social, cultural, and educational hub of the campground for ranger naturalist programs and other shared activities (McClelland 1998). Campground development continued into the 1920s under the guidance of landscape architects Daniel Hull and Thomas Vint. During this time, housekeeping cabins and camps were introduced, becoming popular with auto-tourists and concessioners like Fred Harvey. Their design followed that of current motor and cabin court layouts of the time and evolved over the 1930s and 1940s, with a grid or other arrangement of cabins located around a primary community building. By 1927, Thomas Vint was solely in charge of the recently formed NPS Landscape Division, located in San Francisco. Staffed with professional designers, the office created guidance for the director and superintendents for park design, development, and management, setting in motion an era of park development and master planning, style, and a landscape preservation ethic for the decades that followed.

1930S: RUSTIC CAMPGROUNDS

Beginning in 1933 with Depression-Era relief funding and work programs, the National Park Service had the means to implement master plans begun in the late 1920s. New Deal programs allowed building and development within parks to take place at an unprecedented speed. Park construction and planning work received funding primarily through two major programs: federal projects funded by emergency appropriations administered through the Public Works Administration (PWA), and Emergency Conservation Work (ECW) carried out by the Civilian Conservation Corps (CCC) (McClelland 1998). PWA work was carried out by skilled labor provided by private contractors according to NPS standards. This contrasted with Emergency Conservation Work, which was an interagency effort between the Departments of Labor, Army, Interior, and Agriculture administered by an interagency advisory board and officially named the Civilian Conservation Core in 1937 (McClelland 1998, p. 328). To keep up with design demand, Vint increased his staff with an additional 24 designers by 1934 and relocated his office operations to Washington DC under a new title of Chief Architect. Charles Peterson managed the Eastern Division out of Yorktown with William Carnes leading the Western Division from San Francisco (McClelland 1998). This set in motion design for NPS campgrounds, both tent and cabin layouts, across parks in the west and east, with specific design work implemented with regional influences.

Park master plans, as envisioned and executed by Thomas Vint and his team, included the location of campgrounds, their layout, and relationship to park roads, trails, and developed areas. Structures prescribed by master plans were created in the rustic style of architecture and the naturalistic style of landscape architecture, the official design idioms of the agency adopted by the late 1920s. Thousands of campgrounds were built according to this planning and design philosophy. Elements of rustic design focused on the use of native materials (stone, timber, and native plants), rugged proportions, and naturalistic, informal siting. Key designers of influence included Olmsted, Robinson, Richardson, Hubbard, and Waugh, who taught a young Conrad Wirth (future NPS director) in landscape design at Massachusetts Agricultural College, now the University of Massachusetts, Amherst.

Campground siting was determined using the familiar criteria but also with additional concerns of scenic preservation (not having an impact on the larger park scenery) and lacking visibility from scenic roads. To provide screening, campgrounds were typically located in forested or vegetated areas. The “Meinecke System” created by Dr. E. P. Meinecke, a plant pathologist, was applied as the design template for delineating access, preventing soil compaction, and avoiding loss of vegetation after its introduction by the United States Forest Service (USFS) in 1932. Meinecke’s guidance was in direct response to earlier campground siting and mistakes, centered on disorganized placement of automobiles, tents, and walking trails. Meinecke believed the greatest damage done to natural resources was from automobiles and focused his efforts to create campgrounds and campsites that would protect natural features while creating an outdoor home for visitors (McClelland 1998). Meinecke’s guidance included instructions for selecting campground sites with good soils that could support tree growth and avoid compaction, ideally with boulders and other natural outcroppings. Length of season was also considered along with the type of natural vegetation that would create a more useful and desirable camping experience. Meinecke assumed that most campers did not know how to take care of the natural environment around them so he believed that careful planning and a minimum number of signs but with barriers and other infrastructure would guide behavior on where to be and where not to go. Part of this infrastructure included the design of individual sites that were

similar in size, with the same level of advantages and features. New roads could be extended out from this plan with new campsites added as needed.

Following Mienecke's guidance, the actual implementation of the typical 1930s campground resembled a compound leaf:

“a two-way gravel road with branches that led to one-way gravel loops. The two-way road, the stem of the compound leaf, was 16-18 feet wide. Each one-way loop, the individual leaflets, was 10 – 12 feet wide. A secondary level of organization was then applied: a branching pattern of parking spurs, angled in the direction of travel,

emanating from the two-way road and one-way loops. Each spur, approximately 10 feet wide and 12-16 feet long, was delineated by rock barriers, or whole logs. Rocks were bedded in the ground in the natural orientation of their strata (Dolan 2020).



Figure 1.4 1930s to 1940s. The loop campground roads with parking spurs is a signature of 1930s "Meinecke System." The system included one-way loop campgrounds with parking spurs; rustic style picnic tables and fire grates at every campsite; group amenities provided, including comfort stations, picnic areas, fire rings and water spigots.

Logs were laid end to end, with the line of logs sometimes punctuated by boulders or the logs seated on short cross logs, elevating them slightly off the ground. Each parking spur signified the location of a campsite. Campsites were located near the parking spur, slightly further from the road, where an approximately 12 x 12 foot relatively level, open area would contain a rustic log picnic table, a stone firepit, and a space for pitching a tent. One 1930s campground commonly offered 100 to 250 campsites. Each campsite was nestled within the overstory canopy of larger trees and buffered by understory and groundcover vegetation, providing privacy between sites. Vegetation was conserved during the lay-out and construction of the campground and supplemented by plantings of native groundcovers, shrubs, and trees. A system of trails delineated by rock edging threaded the campsites together and led to shared services, including restroom structures with flush toilets (in convenient but discrete locations), a community campfire circle or amphitheater, water spigots, and trash collection areas. Larger campgrounds were planned with additional shared services, such as community buildings for evening programs, community kitchens or cook shelters, and a zoned picnic area with clustered tables and picnic shelters” (Dolan 2020).

Architects like Herbert Maier and Cecil Doty helped defined the NPS approach to rustic structure design located in campgrounds and across park villages. Following Meinecke's sensitive design recommendations for campgrounds set to preserve natural features and overall scenic quality and with an understanding of Vint's comprehensive approach through the master plan, Maier created a complimentary set of guidance for rustic architecture that defined the 1930s and the work of the

Civilian Conservation Core. Maier recommended that buildings should harmonize with the surrounding environment but be secondary to that landscape. Further, he recommended that buildings should also be in harmony with one another in materials, form, and massing. To make buildings and structures secondary to the environment, Maier recommended the avoidance of straight lines, the use of native stone and log materials, and that those materials should be in scale with the larger landscape. Lower-pitched roofs were recommended along with the use of strong horizontal elements. Colors tended toward natural tans and browns, which blended with the ground and surrounding vegetation. Maier recommended screening buildings with vegetation and encouraged a blur between the natural and the built environments (McClelland 1998). Maier led with examples of successful construction projects, showcasing this work in his own source libraries and with field photographs. He built an architectural approach that led not by standardization of design but rather a flexible, creative approach that valued and understood the intersection of site, setting, building, and cultural influences from a particular park or environment (McClelland 1998).

The Civilian Conservation Core worked at an astounding rate, building out national, state, and municipal parks, primarily led by the National Park Service during the 1930s. As the Federal Unemployment Relief Act was signed in 1933, the National Park Service was ready to put thousands of unskilled men to work. By mid-May of that year, the National Park Service prepared to open 63 CCC camps to accommodate 12,600 men in NPS units. By the end of that year, 35,000 men were enrolled and working in state and national parks under the supervision of 2,300 professionals. Additional park design help came to the National Park Service through the Works Progress Administration (WPA), created in 1935. CCC workers followed the guidance set forth by designers and scientists like Vint, Meinecke, and Maier, working to protect natural and scenic qualities of parks, while creating much-needed infrastructure. Consequences of the 1930s campground design included the archetypal image of the rustic campground as a unique place evocative of its surroundings. These campgrounds were hugely popular and garnered support from a generation of campers drawn to the national park concept. These campgrounds were not available to all, however. Campgrounds were typically used less by people of color, and some campgrounds were racially segregated (Dolan 2020).

As World War II began, staffing and visitation quickly declined in national parks. The Civilian Conservation Core was officially decommissioned in 1942, and the National Park Service began to consolidate positions into regional offices. With less field time available, designers were less familiar with park sites and specific needs. Because of this, work continued but lacked the craftsmanship and site specificity of the pre-war days (McClelland 1998). Many campgrounds during this time fell into disrepair due to lack of funding, maintenance, and use. “Waterlines corroded, masonry features were storm damaged, trees fell, vegetation re-colonized some areas, campsites eroded, and wood features rotted. When visitation rebounded after the war, these 1930s rustic campgrounds were in a severely deteriorated condition” (Dolan 2020).

1950S – 1960S: MISSION 66 AND CAMPGROUNDS

At the end of WWII, NPS Director Drury called for a new program that urged the redevelopment of public works programs as seen during the depression era to address the backlog of projects that had occurred during the war. With this request, he called for the control of visitation that increasingly destroyed natural features in parks. Additionally, Drury asked for the removal of concessioners and to create a solution for continued growth and expansion of campgrounds, especially in environmentally sensitive areas. What followed, named the Mission 66 program and under the

direction of Director Conrad Wirth, was far larger than Drury's initial requests and expanded park infrastructure beyond anything yet built. Mission 66 was a capital investment campaign providing two billion dollars for infrastructure over 10 years, culminating in the 50th anniversary of the agency in 1966. Designed for the new age of automobile tourism, Mission 66 followed a similar master planned effort (still under leadership of Thomas Vint until 1961) and introduced a new type of park structure, the visitor center. Existing campgrounds were expanded to increase their capacity, others were built new, or some were relocated to areas considered more protective of resources than their 1930s predecessors. Campground alterations or new builds were prescribed by the Mission 66 Prospectus for each park. During this period, thousands of new campsites were built and considered a critical component of Mission 66 planning. In 1955, the National Park Service had approximately 12,000 campsites and anticipated a need to more than double that number by 1966 (Carr 2007). Campgrounds prescribed or altered by the Mission 66 program were executed following the tenants of Modernism (in both architecture and landscape architecture) overlaid upon the principals of the Meinecke System. While Modernism shifted some aspects of park design away from that of the New Deal period, other aspects lined up well with standards of practice carried forward by Meinecke, Vint, and architects like Maier. Differences included a shift from the picturesque and hand-crafted to the design of landscapes for human use, with a tie to machine production. Further, Modernism favored a shift from pattern and plan to a focus on design for space and volume (Trieb 1993, pp. 53–55). Aspects of Modernism that were more in line with New Deal campground design concepts included the use of local plant materials for their botanical and ecological qualities and the preference for integration of indoor/outdoor space as already set in motion with the advent of structures like the amphitheater and the concept of a campsite as outdoor home (Trieb 1993, pp 53–55). Further, Mission 66 structures, while constructed differently and with materials tied to mass production, still favored the asymmetrical, horizontality found in rustic architecture and often prioritized sensitive siting in the landscape, taking advantage of topography and natural features to screen and blend with park landscapes.

Conrad Wirth believed that the Mission 66 program, through design efforts, would follow early twentieth-century standards of park resource protection through better direction and control of visitors. Wirth hoped to use park infrastructure, including campground design and placement, to “localize, limit, and channel park use” (Carr 2007, p. 281). The program focused park development in areas already used for development rather than pushing farther into undeveloped areas or wilderness zones. Mission 66 also attempted to remove unwanted or badly deteriorated developments (Carr 2007). Structures, furnishings, circulation systems, and signs attempted to provide utility, durability, and economy as their first priorities, rather than harmony with nature. Efficiencies of scale were found in mass produced, industry standard materials and construction methods, rather than the hand-crafted methods used by Depression-era work forces. The implemented form of the 1950s – 60s campground resembled a bunch of bananas:

a set of elongated loop roads (the “bananas”) emanating in series from a main access road. All aspects of the layout were scaled up from the 1930s template: the main access road was a two-way, 18 – 20 feet wide road, usually asphalt-paved, leading to one-way loops, 12 -16 feet wide, also often paved, with minimum curve radii of 35 feet, allowing for trailers, trucks, and larger automobiles. The angled parking spur remained: now, spurs were scaled up to 12 feet wide x 25 feet long. Delineation of parking spurs was more often by peeled logs or milled wood bollards, rather than rock. Campsites were scaled up to 20 x 20 feet, to receive a metal and precast

concrete fire grate or barbeque grill, a tubular metal and milled lumber picnic table, and a tent site. A 1950s – 60s campground commonly offered 400 – 600 campsites, in loops typically labelled “A” through “F”, or more (Dolan 2020).

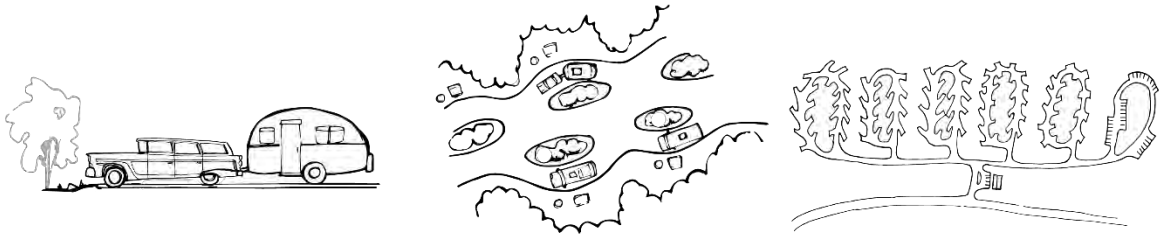

Figure 1.5 1950s. Mission 66 (1956) ushered in new campground design. This included large, multi-loop road campgrounds; large parking spurs or pull-through turnouts for parking; large campsites; mass-produced picnic tables; and fire grates/grills at each campsite. Group amenities were also provided.

“Trails interlacing individual campsites were still part of the 1950s – 60s campground, often with stone or rock delineation, along with community campfire circles of native rock. Restrooms with flush toilets, shower houses, trash collection areas, water fountains, and dish washing stations followed industry standard approaches in design, using cast-in-place concrete, concrete masonry units, milled lumber, and rectilinear forms. Vegetative screening between campsites was desirable, though less emphasized than during the 1930s. Increased carrying capacity and effective functionality for vehicles and people were greater priorities than seclusion from other campers” (Dolan 2020)

“The consequences of the 1950s –60s campground design included mass visitation and campground use throughout the park system, galvanizing the experience of the annual family camping trip, available to a greater economic diversity of visitors. While racially segregated campgrounds no longer existed in the national parks, in most regions, campgrounds were used less by people of color. During the Mission 66 period, the park system grew by more than one third, and visitation increased more than ten-fold over pre-World War II levels. Campgrounds were more standardized and less unique to each locale, but more predictable and more comfortable” (Dolan 2020).

CONCLUSION

A common thread of landscape protection and preservation runs through campground design from the early years of the agency to the present day. In the mid-1960s, environmental studies and legislation helped support this thread. The 1963 Leopold Report called for the protection and preservation of park biota and recommended sensitive park design and development to balance the mission of the National Park Service. The Wilderness Act of 1964, with the National Park Service following in 1966 with the development of Wilderness Management Criteria guided limits on park development. The National Historic Preservation Act of 1966 asked the National Park Service to consider effects on any structures and developments located in national parks that may have historical value. The National Environmental Policy Act of 1969 required parks to take an overall look at the environmental effect with any new projects. Ecologist Fraer Darling and geographer Noel D. Eichhorn published “Man and Nature in the National Parks: Reflections on Policy in 1967.”

This paper praised the sensitive design efforts of the 1930s as an optimal time in NPS development where a balance was struck between nature and human use. This ethic influenced the 1982 Federal Highway Act that funded park road construction and rehabilitation projects (McClelland 1998, p. 477). During the 1970s, master planning efforts also reflected environmental and ecological concerns, showing the constant need within the National Park Service to balance the dual mission of resource protection and preservation with park visitation and visitor experience. However, Mission 66 was the last “consistent, ambitious, systemwide redevelopment” program of the National Park Service (Carr 2007, p. 340). Because of this, the program’s master plans and structures still guide much of how visitors use, enjoy, and experience park landscapes. New design and construction in the National Park Service now fall into a decentralized system, tied to individual park efforts or in collaboration with outside partnerships. This guide intends to promote a more centralized approach towards campgrounds, while still allowing parks to adapt and tier a campground project to their individual park.

The design of campgrounds evolved over time to respond to changing visitor uses and technologies. The changes helped to shape what visitors now identify as an NPS campground. Critical campground site components, such as a fire ring, picnic table, comfort station, and access to drinking water will remain integrated in a modern campground. As will the identifiable loop layout delineated with native vegetation and parking spurs; however, accommodations will be made to adjust to more inclusive campgrounds. Campgrounds that are accessible to users of varying abilities result in increased opportunities to experience park environments. Campground design, as relevant today as it was throughout the history of the National Park Service, remains rooted in resource protection and visitor enjoyment. As the National Park Service moves into a second century of campground use and design, future development and modernization of campgrounds will maintain the fundamental underpinning components of a traditional campground, while adapting to changing uses and technologies.

"We study the past to understand the present; we understand the present to guide the future." - William Lund



Figure 1.6 Big Cypress National Preserve, Florida, Midway Campground sized for large RVs.

BRIEF TIMELINE

See appendix B for additional details.

- **1916:** Stephen Mather writes “Progress in the Development of the National Parks” in which is set forth his vision for the national parks comprehensively and as a system. To this accessibility was key—by rail or roadway.
- **1916:** Stephen Mather envisions a National Park-to-Park highway Association connecting western parks as visitation increases dramatically. Free Automobile camps open in each park with services such as water, cooking grates, and toilet facilities. These are created in cleared areas with access to nearby supplies and fuel (McClelland 1998).
- **1918:** Secretary of the Interior Franklin Lane creates a statement of policy for the National Park Service. In this he creates three fundamental principles supporting the 1916 Organic Act. From this, focus on accommodations should serve various classes of visitors from low-priced camps to high-end hotels. This included, as funds allowed, the National Park Service would create and maintain a system of free campsites. These would be in cleared areas with water and sanitary service (McClelland 1998, p 135).
- **Mid-1920s:** Housekeeping camps are introduced as a concept. This type of camp helps standardize cabin and other building design to be used throughout the new deal era.
- **1933:** The Civilian Conservation Core is formed as the Emergency Conservation Work agency.
- **1934:** E. P. Meineke writes *Camp Planning and Camp Reconstruction*.
- **1934:** the National Park Service produces publications on park design: Portfolio of Comfort Stations and Privies; Portfolio of Park Structures—Dorothy Waugh completed these. These two volumes addressed many small structures located in campgrounds.
- **1935:** Albert Good edits “Park Structures and Facilities” for the National Park Service. It is a bound book of successful design work completed by the Civilian Conservation Core for both state and national parks (with heavy focus on state parks).
- **1939:** The National Park Service issues “Master Plans: A manual of Standard Practice for Use in the NPS” (McClelland 1998, p. 311).
- **1954:** The Federal Highway Act of 1954 helps parks with the flood of visitors by providing three years of funding for park road development.
- **1955:** Fifty million people visit national parks. The parks are equipped to handle half that number. Park visitors want a different experience at this time, and park visitation areas are too small and in poor condition.
- **1957:** Following Mission 66’s first year, 1,150 projects are set as part of the initial construction program at a total of \$75 million with room for 2,300 additional campsites, 930 new, and 1,300 improved campsites (McClelland 1998, p. 469)
- **1958:** Mission 66 program completed 3,200 campsites.
- **1960:** The National Park Service had developed 7,000 individual campsites and rehabbed another 4,000 (Carr 2007, p. 292), with hundreds of campfire circles and amphitheaters created. (Carr 2007, p. 293)
- **1968:** The Architectural Barriers Act (ABA) was established and was one of the earliest measures by Congress to address access to the built environment, requiring facilities designed, built, altered, or leased with federal funds to be accessible according to established standards.

- **1973:** The Rehabilitation Act of 1973, Section 504, was established and requires access to programs and activities that are funded by federal agencies, including provisions for effective communications and equal benefit. Later amendments strengthened requirements for access to electronic and information technology (e.g., websites and electronic interpretive media) in the Federal sector (Section 508).
- **2000:** DO#42: *Accessibility* came out and provided a comprehensive approach to providing accessibility in programs and services for visitors with disabilities.
- **2020:** The National Park Service Second Century Campground Design Guide is developed.

This page intentionally left blank.

CHAPTER TWO: SCOPING, COMPLIANCE, AND DESIGN

PROJECT SCOPING CONSIDERATIONS

Beginning with Project Scoping Considerations, the content of this guide starts with a project concept, information gathering, and development of a Project Management Information System statement (PMIS). Within the next few sections, the user can find considerations that are most often needed at the front end of a project to remind the reader of a variety of considerations through links and simple direction. The information is not intended to replace a National Park Service or park specific process but to point users to locations for more information. The topics in this section include:

- Understanding the visitor
- Investment and management tools
- Baseline documentation – Cultural Site analysis
- Design considerations
- Compliance considerations

After the Project Scoping Consideration phase, the Design Guideline section provides programmatic and design details relevant to campground design. This includes a range of scales from overall site layout to water spigot details. The compilation of information is intended to increase understanding of scoping requirements (e.g., how many comfort stations are needed) and specific construction requirements (e.g., how to construct a fire pit). Accessibility will be included throughout the document. The information within this section is arranged as a visitor would experience a campground, beginning with site access and layout and completing with site-specific details. This toolbox of information can be used in a comprehensive campground project or a specific upgrade project.

UNDERSTANDING THE VISITOR

There are a variety of reasons visitors stay at National Park Service campgrounds. NPS surveys commonly group campgrounds more broadly with facilities (e.g., comfort stations, visitor centers, etc.). This can limit the clarity associated with motivations, evaluations, and other survey results. Additionally, the need for results from a specific campground may also not be available with park-wide visitor surveys. An inclusive NPS campground must consider the needs of not only the current visitor, but the future visitor and visitors that may not be currently using NPS campgrounds. By better understanding current and future visitors, the National Park Service can create spaces to provide a range of camping opportunities and facilities that align with visitor needs and expectations.



Figure 2.1 Redwoods National Park, Prairie Creek Campground.

Historical data should be examined to understand how campgrounds are currently used. This should include information such as the current type and number of sites, how often those sites are filled, and the average length of stay among visitors. Some of this data can be found at ([National Park Service Visitor Statistics](#)). Some parks may also have data collected from visitor use and experience surveys specific to certain campgrounds or overnight visits. Survey data can be found ([add link](#)). Data regarding visitors or potential visitors may be collected outside the National Park Service and can offer insights to camping use and experience in the surrounding area. Two recent market analysis trends reports contracted by the National Park Service in fall 2019 indicate the top self-reported reasons visitors stay at National Park Service campgrounds as the following:

1. Diverse Camping Opportunities (RV, tent, cabins)
2. Location of Campgrounds
 - a. Geographically close to where people live
 - b. Close to recreational opportunities and attractions (hiking and backpacking are at the top of the list)
 - c. Located in the iconic places and natural resources of the National Park Service
3. Atmosphere of the campground and services provided.
 - a. Family-friendly campgrounds
 - b. Place to relax and get away
4. Desire to explore new destinations

Copies of the full reports can be found [here](#).

If a park does not have any existing information or the available information is dated or limited, the park should consider collecting data concerning visitor use, experience, and preferences. Parks should consider populations of interest, including current visitors, as well as people or visitors who are currently not using NPS campgrounds as an overnight opportunity. To obtain information from the target populations, a variety of social science methods can be employed ranging from on-site visitor intercept surveys to online household surveys. The best methods to obtain information will depend on the target population. Examples of previous surveys can be found here ([add link later](#)). While few parks are equipped with staffing and expertise to employ their own visitor surveys, the Social Science Branch of the Environmental Quality Division of the National Park Service can assist. (A link to the Social Science Branch website can be found here: [Social Science](#)). Additionally, the Social Science Branch is responsible for reviewing all NPS sponsored social science surveys, which must receive Office of Management and Budget approval as per the Paperwork Reduction Act. More information about this process can be found here: [Social Science Information Collection](#).

Parks should consider a range of visitor questions, such as:

- What kind of camping is desired (RV, car, tent, bike, walk-in)?
- How long are visitors expected to stay?
- What services do visitors want (group sites, cabins, electric sites, etc.)?
- What is the socio-economic status of visitors?
- What are the appropriate visitor price points?
- How can the campground be more welcoming and inclusive for diverse visitors?
- How many sites should be reservable and how many first come, first serve? Studies have shown most visitors have a preference for reservable sites.

- What are current uses and how do they differ from desired uses?

Understanding the visitor enables the National Park Service to create more inclusive campgrounds by planning facilities, services, programs, and activities around a diverse group of visitors.

Accessibility

One in four people in the United States lives with a disability (CDC 2019). National Park Service visitors include people with disabilities, and the National Park Service is committed to ensuring that people with disabilities have equal opportunity to benefit from NPS facilities, programs, services, and activities. As a federal entity, the National Park Service is required by law to comply with the [Architectural Barriers Act of 1968](#) (ABA) and the [Rehabilitation Act of 1973](#). The [accessibility of commercial services](#) within national parks is also covered under Title III of the [Americans with Disabilities Act of 1990](#). The National Park Service sets forth its internal policies on accessibility in [Director's Order 42: Accessibility for Visitors with Disabilities in National Park Service Programs and Services](#).

Learn more about standards of these laws on the [US Access Board website](#). Legal requirements outlined in the US Access Board Standards are a requirement for all new and rehabilitated construction. Within the standards are scoping requirements for the minimum number of accessible elements (e.g., campsites) and technical requirements for ground surfaces, reach ranges, clear knee and toe spaces, RV and other vehicle parking, etc. These standards are minimums. As much as possible, the National Park Service should strive to exceed the standards and provide more than the minimum legal requirements. This will allow more flexibility for all park service visitors and create a more welcoming environment for everyone. Flexibility also reduces the burden of operations when accessible camp services exceed the minimum required by law. (For instance, a campground with the minimum of one accessible site must manage access of this site for visitors with disabilities.)

National Park Service policy and Directors Order 42 ([DO-042](#)) require the application of Universal design principles and goals. Universal design is the design of products and environments to be usable by all people, to the greatest extent possible, without the need for adaptation or specialized design. Universal design exceeds the standards of ABA and strives to include all people in the same experience. There is no legal requirement to meet Universal design principles rather than the ABA Standards. However, making facilities, programs, services, and activities more user-friendly to all people no matter their abilities or disabilities is a worthwhile endeavor.

Throughout this guide, references are provided to the most common codes for each service or facility, but the guide is not intended to duplicate the standards in their entirety. Designers should always reference the [full code](#) to understand all requirements. In some locations, additional resources are given to accompany the code (such as American National Standards Institute, ANSI, or US Forest Service). ABA standards are the final legal requirement. Prior to the initiation of construction or rehabilitation of campground facilities or interpretation features, all project plans should be reviewed by accessibility experts. Parks without accessibility expertise should contact regional accessibility coordinators. This will ensure compliance is met and provide the opportunity for recommendations for universal design. The most cost-effective time to correct deficiencies in accessible design is prior to construction. The transition from design to construction is another critical step for maintaining accessibility in physical spaces. Accessibility expertise should be involved during construction inspections before finalization of projects to ensure required measurements, grades, and other standards are met with the final products.

Inclusivity

The mission of the [National Park Service Office of Relevancy, Diversity, and Inclusion](#) (RDI) is to champion for an organizational culture that is increasingly inclusive and participatory, which values the diverse ideas, experiences and background of every individual and empowers an innovative, flexible and resilient National Park Service to engage the opportunities and challenges of the future. To learn more, visit the [RDI webpage](#).

The makeup of NPS visitation is not keeping pace with the changing United States population. Projections by the [Pew Research Center](#) show that by 2050 the population numbers of non-Hispanic whites will drop to half or slightly less than half of the total population. In contrast, the Hispanic population will rise to 29 percent, the African American population will increase to 13 percent, and the Asian American population will increase to 9 percent. Diversity, relevancy, and inclusion must link through all NPS operations, including design and rehabilitation of campgrounds.

Plan for diversity and inclusivity when designing new or rehabilitated campgrounds. Start by incorporating people of different backgrounds, perspectives, thoughts, and beliefs on your planning team. Understand the demographics and motivations of who does and does not visit your park. [\[Link to visitor motivations section\]](#). Partner with organizations to understand how to build more welcoming spaces and more inclusive programming in National Park Service campgrounds. Plan campground design and rehabilitation with flexible spaces that can accommodate a wide range of visitor preferences and abilities. (For example, design a cluster of individual campsites that can be combined for use by larger extended families.) Seek out and include a wide range of services and technologies to attract different users.

INVESTMENT AND MANAGEMENT TOOLS

To better prepare for the future of National Park Service campgrounds, the service commissioned a study in October 2019 to investigate the design, business practices, and required analysis that will support a campground investment strategy. Market analysis trends reports were completed and are available to the public, partners, and NPS staff [here](#). The goals of the study are for the park service to develop tools to make consistent decisions about when campground infrastructure investment is warranted by the National Park Service and what operating model a campground should use.

The prospectus financial model was used to guide the development of these tools. The typical prospectus project includes the creation of an Excel-based financial model that allows park managers to evaluate various investment and revenue options for a new concession contract. Using that basic framework, the consultants hired under the study will develop a financial model that parks and regions can use to consider investment strategies for major campground investment and potential revenue resulting from those investments. These models will also allow park managers to consider whether to develop concession contracts to have a third-party operator manage campgrounds that are not already concessioner run or if it is better to manage a specific campground with park service staff. The intention is not to convert all campgrounds to concessions but rather to ensure consistent decision-making tools are used across the park service. These modeling tools will be available for parks to use as part of their overall campground investment strategy in fiscal year 2021. Once available, this guide will be updated to include links to the investment and management tools.

Concessions

The design guide provides information and parameters on typical campground layouts and services. In many cases, these facilities will be provided by the National Park Service. However, park managers can and should also use investment and management tools outlined above to determine when it is appropriate for a campground to be concessioner operated. Concessioners can install personal property improvements during a contract using ‘personal property structures’ such as camper cabins and prefabricated showers. These types of improvements are removed at the end of the contract term without the park generating leaseholder surrender interest (LSI) or deferred maintenance (DM).

BASELINE DOCUMENTATION – CULTURAL

Campgrounds with historic significance and integrity may be eligible for listing in the National Register of Historic Places as sites or districts. As such, they are identified by the National Park Service as cultural landscapes, one type of cultural resource. Campgrounds may also contain other kinds of cultural resources, namely archeological resources, historic structures, and ethnographic resources. These must be identified before or during the campground planning process. Existing information can be found in baseline documentation.

Baseline documentation for cultural resources is evaluative information used to guide stewardship and avoid, minimize, or mitigate the potential impacts of undertakings, such as campground rehabilitation. Cultural resources baseline documentation is stored in the Cultural Resources Inventory Database (CRIS). This database encompasses cultural landscapes, archeological resources, historic structures, and ethnographic resources. It also consolidates the former Cultural Landscapes Inventory (CLI), the List of Classified Structures (LCS), the Archeological Sites Information Management System (ASMIS), and the Ethnographic Resources Inventory (ERI). In addition to inventories, other baseline documentation exists in the form of resource studies and treatment plans. These types of documents pertinent to campgrounds include the Cultural Landscape Report, an Archeological Overview and Assessment, a Historic Structures Report, and an Ethnographic Overview and Assessment. Resource studies inform campground project planning and design, and treatment plans more specifically provide design recommendations.

The priorities of the NPS mission are guided by the *Management Policies 2006*. Specifically, the policies state that the National Park Service will protect, preserve, and foster appreciation of cultural resources through appropriate programs of research, planning, and stewardship (NPS *Management Policies 2006*, p. 59). More specific NPS guidance is provided in Director’s Order 28: *Management of Cultural Resources*. In addition to this section, see “Preconstruction – Compliance Considerations” in this guide.

Research should inform planning and compliance with legal requirements associated with the National Historic Preservation Act (1966) and the National Environmental Policy Act (1970). Effective planning will provide an understanding of the significance of the park’s cultural resources. Plan for adequate cultural resource identification, evaluation, and associated consultation with partners and cooperating agencies prior to any final treatment development or implementation.

- [NPS Management Policies \(2006\)DO-28](#)
- [Cultural Resources, Partnerships, and Science Directorate](#)
- [Federal Historic Preservation Laws, Regulations, and Orders](#)

- [Archeology Program](#)
- [Historic Structures Report \(HSR\)](#)
- [Cultural Landscape Report](#)

Currently, the NPS Cultural Resources, Partnership, and Science Directorate and the Park Planning Facilities and Land Directorate are collaborating with the National Conference of State Historic Preservation Officers to improve efficiencies in resource identification and evaluations with the intent to improve and expedite baseline documentation necessary for responsible planning and treatment of campgrounds and comfort stations. As that work continues, procedures and processes for implementation of the Second Century Campground Guidelines will be updated.

SITE ANALYSIS

- All designs must adhere to the Organic Act (39 Stat. 535, 16 U.S.C. 1) specifically:

To conserve the scenery and the natural and historic objects and the wild life therein and to provide for the enjoyment of the same in such manner and by such means as will leave them unimpaired for the enjoyment of future generations.

- Facilities will be harmonious with park resources, compatible with natural processes, esthetically pleasing, functional, energy- and water-efficient, cost-effective, universally designed, and as welcoming as possible to all segments of the population. NPS *Management Policies, 2006*.
- Designs must reflect the context of the park unit and local environment (contextual design). Designs must respond to the capabilities of the park unit staff and the local market for support services.

[Above text in call out box, or with other graphic text effect in final]

Site analysis is a preliminary step in the design process, typically performed during predesign (or preliminary design), to analyze potential development sites as it relates to the program, budget and schedule of the project. It evaluates an existing site or potentially new site by identifying specific site issues, such as physical, environmental, cultural, and legal attributes. This informs different opportunities and constraints for alternative uses of the site. It provides direction for design by developing an understanding of the site and program uses. It is used as the basis of design for site selection and/or program development and reinforces goals for a cost-effective, environmentally sensitive, and maintainable and sustainable approach to project development. Consider using Park GIS and survey data to identify areas of vulnerability. (This is especially important for coastal park units.) Site analysis can be prepared as a narrative or in graphic format but should include many of the following:

- topographic analysis
- slope analysis
- analysis of physical features
- accessibility features and deficiencies
- access and circulation, including traffic and parking studies
- archeological sites
- vegetation

- existing water bodies, floodplains, wetlands, drainage ways
- site history
- history of existing structures and landscape
- on-site utility studies
- off-site utility studies
- buildings and structures
- views and vistas
- dark skies
- environmental studies and reports (i.e., snow and wind loads)
- climate studies
- geotechnical/soils
- hydrologic studies, watershed modeling studies
- project requirements
- existing condition assessment; i.e., hazmat investigation
- A review of other park projects and adjacent development (i.e., roadway and infrastructure improvements)

Refer to the National Park Service, Denver Service Center Workflows, DBB 1.0 Predesign (PD)

- 1.1 Prepare Contextual Analysis
- 1.2 Prepare Project Program (site analysis included)
- 1.3 Prepare Integrated Design Narrative

Link to DSC Workflows: <https://www.nps.gov/dscw/dbbpredesign.htm>

DESIGN CONSIDERATIONS

When contemplating a change to an existing campground or the creation of a new campground, many details should be considered, including the following:

- Park staff or designers need to consider if existing infrastructure allows for the capacity for expansion or change in services such as utilities, water, and wastewater.
- Early evaluation of infrastructure capacity is recommended to avoid a large financial outlay for design when capacity may be the limiting factor or if an increase in infrastructure capacity is warranted.
- Some projects may need to be phased either due to budget or site considerations. Designs need to reflect this possibility and how it might impact operations, budget, and visitor experience.
- Understanding visitor motivations will help define spatial requirements. (For example, what is the maximum separation between comfort stations in a campground setting.)
- Design should ensure adaptability for changing users, changing environment, and resilience. (For example, running extra conduits during construction to allow the flexibility to add utilities later.)
- Adequate surveys or confirmation of existing surveys should be provided. (e.g., lidar, GIS, drones, serial photography, potholing for utilities, etc.)

Capacity of existing utilities and infrastructure (safety, water, electric, sanitary, and road design).

- Verify power needs and existing capacity: other entities' (upgrades, meters, transformers, service, etc.), utility easements and possible associated agreements, etc. Larger electrical service or telecommunications may be required to meet increased need (for instance if electrical hookups are added). If larger service is needed, it may require the servicing utility company to upgrade their facilities, or upgrades of facilities may not be possible to meet additional needs. Upgrades may require additional cost for review and approval of design, permitting requirements, and installation of conduit to upgrade electricity. Refer to National Park Service, Denver Service Center Workflows, Section DBB 1.0 Predesign (PD), 1.5 Permitting, Link: <https://www.nps.gov/dscw/dbbpredesign.htm>
- Verify capacity of all existing utility services is adequate for all proposed upgrades. Verify size, type, and condition of all existing utility lines and perform any testing (like flow test) to verify minimum required water pressure and flow is available at the proposed point of tie-in for the water system.
- Build with fireproof materials (if possible).
- Fire alarm emergency response (cell, telephone, fiber connection): confirm the system that is required and check that services can provide uninterrupted response.
- Sanitary sewer services: Verify capacity of leach field, sewer plant, and any downstream effect.
- Consultation with either park staff or concessioner that provide maintenance and service. (This is typically a concern when adding new features like comfort stations or utility access for recreation vehicles.)



Figure 2.2 Glen Canyon National Recreation Area, Lees Ferry Campground.

Permitting

Evaluate potential jurisdictions and agencies that apply to the project. Identify applicable project topics, missing information, and decisions needed to determine applicable permits. Use this information and any information provided by your project to identify required permits. Many permits have a nominal fee, but others can be quite expensive and have long lead times; thus, it is important to know up front what impact they will have on the budget and timeline.

The Denver Service Center (DSC) has a Permitting Assessment Form (PAF) to help frame permitting for park projects. The Excel spreadsheet is useful to document permitting research and decisions.

https://www.nps.gov/dscw/upload/PermittingAssessment_Form_12-2-16.xlsx

Planning

Designers should reference previous park planning efforts such as general management plans, development concept plans, character guidelines, zoning plans, foundation documents, etc. before beginning the design process. This will ensure any new or rehabilitated campgrounds fit within the existing park planning framework.

PETS IN CAMPGROUNDS

Campground visitors often bring pets along on the family vacation. Dogs are the most typical. The National Park Service welcomes pets in developed areas and has pet regulations so all parks follow the same rules. Reference [NPS regulations on pets](#). Service animals are NOT considered pets and are allowed under NPS policy ([Policy Memorandum 18-02](#)) and regulation issued by the Department of Justice for Americans with Disabilities Act (ADA) title 2 & 3. For more detail on service animals in National Parks, please reference information [here](#).

To establish expectations, parks should ensure messaging about pets is clear both in campgrounds and other published visitor information (website, newsletter, etc.) Consider providing written pet rules at campground check in. Typical pet rules (from regulations noted above) include:

- Pets should be crated or restrained on a leash not exceeding six feet in length
- Pets should not be left unattended
- Pets are not allowed to frighten wildlife by barking or chasing
- Pet excrement must be disposed of appropriately
- Campgrounds managed by concessions may have additional rules
- In parks where pets are not allowed, provide a service animal relief area with refuse receptacle.

COMPLIANCE CONSIDERATIONS

The National Park Service is required to follow all law, regulation, and policy. This section includes the most critical but may not be exhaustive.

National Environmental Policy Act

Information on the National Environmental Policy Act (NEPA) included here is derived from the 2015 NPS NEPA HANDBOOK and SUPPLEMENTS. Note that the supplements are a key part of the handbook. The intention in this section is to ensure awareness of the need for NEPA compliance and provide resources to scope projects. The project lead should consider reaching out to the park or region NEPA Coordinator/Lead early in the planning process to help develop the NEPA strategy for a project. The NEPA process is led by the National Park Service, but consultants may be hired to prepare documentation.

Passed by Congress in 1970, the National Environmental Policy Act established a national policy of encouraging productive and enjoyable harmony between human beings and the environment for present and future generations. To further this policy, the National Environmental Policy Act requires federal agencies like the National Park Service to evaluate the environmental impacts of its actions and to involve the public in the decision-making process. Within the National Park Service, the NEPA process is an essential tool for ensuring informed decisions that conserve park resources and values. Below is a compilation of all DOI/WASO orders and memos issued since 2017 regarding the NEPA process and External Review.

The National Environmental Policy Act is far-reaching and is triggered whenever the National Park Service considers an action that could have impacts on the quality of the human environment. In short, the NEPA process is required whenever there is an action: 1) on federal lands, 2) using federal funds, and/or 3) requiring a federal permit.

A good place to start the NEPA process is with internal scoping. Internal scoping refers to the use of an Interdisciplinary Team (IDT) to provide input into a project in terms of issues, constraints, alternatives, impacts, and determining the appropriate NEPA pathway. During internal scoping, your Interdisciplinary Team is encouraged to consider using the Environmental Screening Form (ESF). This form is a tool used to begin the compliance process and to gain a better understanding of resource effects. The Environmental Screening Form was last updated in September 2015 and can be found on the Planning Environment and Public Comment (PEPC) site. Select Step 4 Natural/Cultural Compliance in PEPC and choose Print Forms. Completing this form in PEPC is recommended.

The five-step NEPA process applies to any level of NEPA documentation:

- 1) project identification
- 2) scoping
- 3) develop and analyze alternatives
- 4) documentation
- 5) decision

Some parks create their own compliance procedures and checklists that park staff are required to follow whenever a project is proposed or an action identified that has the potential to affect natural or cultural resources.

The NEPA Handbook can be found here: <https://www.nps.gov/subjects/nepa/policy.htm>

National Historic Preservation Act and Section 106

Passed by Congress in 1966, Section 106 of the National Historic Preservation Act (NHPA) requires federal agencies to take into account the effects of their undertakings on historic properties listed in or eligible to be listed in the National Register of Historic Places and afford the Advisory Council on Historic Preservation an opportunity to comment. Section 106 compliance is coordinated by the National Park Service, but consultants may be hired to provide information for the process. To learn more about the National Historic Preservation Act and the regulations and policies that support it, see “NHPA Law, Regulations, Policies.”

Section 106 consultation is required for any federal undertaking that has the potential to affect historic properties. In short, the National Historic Preservation Act is required whenever there is an undertaking 1) on federal lands, 2) using federal funds, and/or 3) requiring a federal permit. For more on undertakings and the 800.3 clause (no potential to cause effects), see “Undertakings.”

Who and how many participants are involved in the Section 106 process depends on the level of effect and complexity of the undertaking and will include the following:

- Park Section 106 Coordinator
- Cultural Resource Management (CRM) Team (an interdisciplinary team of cultural resource management professionals to provide advice at each step in the compliance process and may include staff from inside the park as well as staff from the Region)
- State historic preservation office (SHPO)
- Tribal historic preservation officer (Tribal Consultation)

The Advisory Council on Historic Preservation’s regulations for Section 106 of the National Historic Preservation Act recommends that processes for the National Environmental Protection Act and Section 106 be combined, when possible, to help streamline these compliance processes. You may combine an Environmental Assessment (EA) or Environmental Impact Statement (EIS) with a Section 106 Assessment of Effect.

Additional information can be found in the NEPA Handbook here:

<https://www.nps.gov/subjects/nepa/policy.htm>

Wilderness

Chapter 6 of the NPS *Management Policies 2006* directs that, for those lands that possess wilderness characteristics, no action that would diminish their wilderness eligibility will be taken until after Congress and the president have taken final action. Wilderness considerations will be integrated into all planning documents to guide the preservation, management, and use of the park’s wilderness area and ensure that wilderness is unimpaired for future use and enjoyment as wilderness.

For additional guidance on wilderness protection and management, see:

- Director's Order 41: Wilderness Stewardship:
https://www.nps.gov/policy/DOrders/DO_41.pdf
- Wilderness Stewardship Reference Manual 41 (RM-41):
https://www.nps.gov/policy/Reference%20Manual%2041_rev.htm

Threatened and Endangered Species Act

Section 7 of the Endangered Species Act (ESA) requires federal agencies to consult with the US Fish and Wildlife Service (USFWS) or the National Marine Fisheries Service (NMFS) when taking an action that may affect federally listed or threatened or endangered species or designated critical habitat. The standard NPS practice is to complete Section 7 consultation before signing a decision document (Section 4.14 of NPS NEPA Handbook). For guidance on completing the steps of the Section 7 process, see:

- USFWS Step by Step Section 7 Guidance
<http://www.fws.gov/midwest/Endangered/section7/s7process/step1.html>

- NOAA NMFS Section 7 Guidance
http://sero.nmfs.noaa.gov/protected_resources/section_7/effects_guidance/endangered_species_act_section_7_effects_determination_web_guidance_final.pdf

Wetlands and Floodplains

Executive Orders 12898 (wetlands) and 11988 (floodplains) govern federal agency actions that may affect these resources. The NPS Director's Order 77-1 (wetlands) and 77-2 (floodplains), and related procedural manuals, provide additional direction. It is highly recommended you contact the NPS Water Resources Division (WRD) Aquatics Branch (<https://www.nps.gov/orgs/1439/ASB.htm>) whenever wetlands or floodplains may be affected by your project—even if you're not sure. The Water Resources Division is an excellent source of information, and specialists there will make sure you are on the right path when it comes to protecting wetlands and floodplains.

For detailed guidance:

- NPS Wetlands Procedural Manual NPS 77-1
https://www.nps.gov/policy/DOrders/Procedural_Manual_77-1_6-21-2016.pdf
- NPS Floodplain Procedural Manual NPS 77-2
<http://www.nature.nps.gov/rm77/floodplain.cfm>

Additional Compliance Resources

Building Codes. The [International Code Council \(ICC\)](#) is a nonprofit association that provides a wide range of building safety solutions, including product evaluation, accreditation, certification, codification, and training. It develops model codes and standards used worldwide to construct safe, sustainable, affordable, and resilient structures.

The links listed below will take you to an external site hosted by the International Code Council:

[International Building Code \(IBC\)](#)

[International Existing Building Code \(IEBC\)](#)

[International Plumbing Code \(IPC\)](#)

[International Mechanical Code \(IMC\)](#)

[International Residential Code \(IRC\)](#)

[International Fuel Gas Code \(IFGC\)](#)

[International Fire Code \(IFC\)](#)

[International Energy Conservation Code \(IECC\)](#)

Additional Electrical code is available here:

- [National Electrical Code \(NEC\)](#)

Structural Fire

- [Structural Fire Reference Manual 58](#)

Sustainability

- [Sustainability QA Review Checklist](#)

Tribal Consultation Policy

On November 5, 2009, President Barack Obama issued a Presidential Memorandum directing each agency to submit a detailed plan of action describing how the agency will implement the policies and directives of Executive Order 13175.

<https://www.doi.gov/tribes/Tribal-Consultation-Policy>

Universal Design and Accessibility

Accessibility Compliance: Compliance with [Section 504](#) and [Section 508](#) of the Rehabilitation Act are legal requirements for all federal agencies.

Universal Design: The design of products and environments to be usable by all people, to the greatest extent possible, without the need for adaptation or specialized design. National Park Service policy and Directors Order 42 ([DO-042](#)) require the application of universal design principles and goals.

Links for Accessibility Standards

- <https://www.access-board.gov/guidelines-and-standards/communications-and-it/26-255-guidelines/825-principles-of-universal-design>
- <https://www.access-board.gov/guidelines-and-standards/recreation-facilities/outdoor-developed-areas/a-summary-of-accessibility-standards-for-federal-outdoor-developed-areas/camping-facilities>
- The Department of Justice has assembled this online version of the official 2010 Standards to increase its ease of use.
- https://www.ada.gov/2010ADASTandards_index.htm

Other NPS Specific Issues

There may be concerns or policies that the National Park Service or your park follow that can have an impact on the design and construction of your project. For example:

- NPS policy requires all fire alarm devices to be NON-PROPRIETARY; certain manufactures are not compatible.

DESIGN PROCESS

Campground design often includes common sequential components. This will vary from project to project. The following list is a brief overview of common sequential considerations; it is not inclusive of all facilities and furnishings. Aesthetic considerations must also be included as an overlay to guide design.

1. Roadway layout within the campground
 - a. Geometry
 - b. Grades
 - c. Drainage and culverts

- d. Basic utility layout and planning
 - e. Material volumes (earthwork cut/fill, aggregate, asphalt)
 - f. Site clearing (trees and rocks)
2. Determine facilities to be provided
 - a. Comfort stations, shower, administrative buildings, electrical hookups, etc.
 - b. Size systems related to facility – water, wastewater, electrical, etc.
 3. Campsite layout design
 - a. Campsite types and layouts, fit to site (including camp hosts, volunteer sites, etc.)
 - b. Locate facilities on the site (including trash and recycling locations, comfort stations, etc.)
 - c. Trails to facilities
 4. Define site furnishings
 - a. Picnic tables
 - b. Fire ring
 - c. Concrete or aggregate pad for parking, tables, and tents
 - d. Bear box (if applicable)
 - e. Directional signs and other signs
 - f. Shelters/pavilions/wind barriers
 - g. Other miscellaneous as applicable (light hangers, hammock stands, dog bag dispensers, etc.)
 5. Barriers, landscaping and irrigation (if applicable)

SITE DEVELOPMENT

New campground construction or an extensive renovation will likely involve site preparation and earthwork. Having a general understanding of this process will help make the permitting and compliance processes more efficient. Generally, permitting is required when there is substantial surface disturbance (1 acre or more) that could affect stormwater. Compliance review is required because the project will likely impact vegetation, habitat, wildlife, and potential cultural resources.

Defining Site Development

Proper site preparation means fewer frustrating setbacks during construction but also avoids running afoul of local and federal rules and NPS guidelines. Site preparation and site development include the following:

- Soil Survey: Geotechnical report related to site soil properties
- Brush Removal or Grubbing: first the vegetation is cleared and then the surface soil layer is removed.
- Tree Clearing and Limbing: Removing trees and limbs is very labor intensive. It requires proper equipment and an experienced contractor.
- Stump and Embedded Rock Removal: Stumps and large boulders can create major problems for contractors and can impact layout of program (i.e., location of roads and utilities)
- Erosion Control: Control of surface runoff and soil loss. Erosion control is planned in the design phase and implemented by an experienced team.
- Excavation: The use of manual tools or heavy equipment to remove material from the surface, usually soil or rock. Digging is the combination of two processes, the first the

breaking or cutting of the surface and the second the removal and relocation of the material found there.

- Trenching: Trenches are often created to install underground infrastructure or utilities (e.g., gas main lines, water main lines, or telephone lines), or later to access these installations.
- Grading: To reconfigure the topography of a site or to stabilize slopes.
- Fill Export/Import: Land clearing also includes removing excess soil or bringing more material onto the site.

Low-Impact Development

Low-impact development (LID) is a term used to describe a site planning and engineering design approach to manage stormwater runoff that preserves the site's natural hydrological and biological character. Low-impact development emphasizes conservation and use of on-site natural features to protect water quality. Conventional processes often drastically alter the site and thereby require greater inputs to mimic natural functions like large culverts and detention basins. The comprehensive approach of low-impact development starts from the beginning of the design process through thoughtful site layout, strict controls on land clearing, and appropriate site elements being away from sensitive areas. Campground projects can implement low-impact development in site development by implementing some of the following:

- Minimize impervious surfaces and roads
- Minimize the area of construction and material storage
- Maintain the existing topography and drainage systems to greatest extent possible
- Involve park and region resources early in the design process
- Establish tree and habitat protection zones in design and construction phases
- Conserve existing topsoil

Restoration

Restoration of soil and vegetation impacted by development activities will help stabilize construction sites, minimize impacts to natural and cultural resources, and protect infrastructure investments. As a land management agency, the National Park Service has unique policies that direct projects to incorporate site revegetation and restoration into project costs ([NPS 2006 Management Policies](#) Section 9.1) and specify genetically or site appropriate plant materials be used in all revegetation work ([NPS 2006 Management Policies](#) Section 4.4). Best management practices for addressing site impacts include:

- Remove all road base, gravel, and nonnative soil material in abandoned or decommissioned areas.
- Decompect soils impacted by new and old construction activities.
 - Assure soils, especially those with a clay component, are decompact or loosened to a depth that will accommodate the root zone of desirable plants.
- Amend soils as necessary. Severely degraded soils may benefit from the incorporation of mulch or compost material. Send soil samples to local laboratory for evaluation.
- Avoid importing topsoil that may be infested with pathogens or nonnative invasive plants.
- Use plant materials that are both native and genetically appropriate to the revegetation area.

- Incorporate erosion control products that are weed free, wildlife appropriate, and free from all synthetic fibers.

The Denver Service Center’s Revegetation Program’s purpose is to assist project managers and park units in successfully delivering projects that comply with the high standards of resource management that are part of the culture and policies of the National Park Service.

The Revegetation Program services include:

- Developing revegetation plans, specifications, and cost estimates.
- Facilitating revegetation project implementation, including invasive plant control, topsoil management, erosion control, native seed collection, seed increase, plant propagation, and reseeded.
- Preparing and overseeing revegetation related contracts.
- Providing biological and ecological technical assistance to project managers and park staff.
- Assisting in the development of genetically and site appropriate plant materials and seed mixes.

Invasive Plants.

- National Park Service Invasive Plant Management Program: <https://www.nps.gov/subjects/invasive/20-years-ipmt.htm>

Native plants.

- NatureServe: <https://www.natureserve.org/>
- SEINet: <http://swbiodiversity.org/seinet/>

Revegetation Information.

- Roadside Revegetation: <http://www.nativer revegetation.org/>
- Caltrans Erosion Control Toolbox https://dot.ca.gov/hq/LandArch/16_la_design/guidance/ec_toolbox/index
- Natural Resources Conservation Service (NRCS) Web Soil Survey <https://websoilsurvey.sc.egov.usda.gov/App/HomePage.htm>
- Xerces Society Pollinator friendly plants and research: <https://www.xerces.org/>

CHAPTER THREE: CAMPGROUND DESIGN GUIDELINES

This guide is meant to be a broad resource for modern campground standards. It is intentionally not region or park specific and does not replace individual park character guidelines. This guide is also not intended to create campgrounds that are all the same. To appeal to all park visitors, the National Park Service should continue to offer a full range of recreational opportunities and experiences with facilities that fit into the local character of each park. These experiences occur on a spectrum as shown in the following United States Forest Service graphic:

[graphic to be added showing the recreation spectrum]

ARRIVING AT THE CAMPGROUND

Before arrival. The use and advancement of technology has increased since most National Park Service campgrounds were built. Visitors want the ability to plan vacations ahead of time and NPS campgrounds need to adapt and accommodate these changes if possible. Adding campsites to Recreation.gov with detailed site information such as size of parking stall, what equipment will fit, and the general services provided will give visitors the ability to book a campsite that is right for them in advance. There is still a desire to have first-come, first-served sites available for the on-the-whim traveler. This can be accommodated within Recreation.gov by using shorter booking windows and allowing same day reservations. It is beneficial for visitors arriving without a reservation to know which sites are available when arriving without having to drive through every campground loop. These goals can be accomplished through the recreation.gov application, signs posted at the park entrance station, campground entrance, an electronic reservation kiosk or other means, to communicate the campground's current availability in real time. Yellowstone [National Park's live map](#) initiative is a successful example of providing real time data to assist visitors in planning for camping. Park websites should also provide accurate camping information. Providing different options for campsite reservations and site selection will help create a better visitor experience for all types of campers and include those that want reservations and those that want to walk-up opportunities.

Arrival. Arriving at the campground gives a visitor their first impression of what to expect throughout their stay. A well-designed, easy to follow road system sets the stage for the visitors' experience and impression of the facility. Well-placed signs that clearly direct visitors on where to pay fees, find their campsite, and understand the rules and regulations will provide the necessary information to make sure they have a great stay and minimize management issues for staff. Accessible sites should be reserved for visitors with disabilities; a set cut-off time should be defined and advertised.

Detailing the design of the entrance station or fee kiosk to match the overall park design character will ensure a cohesive park feel.

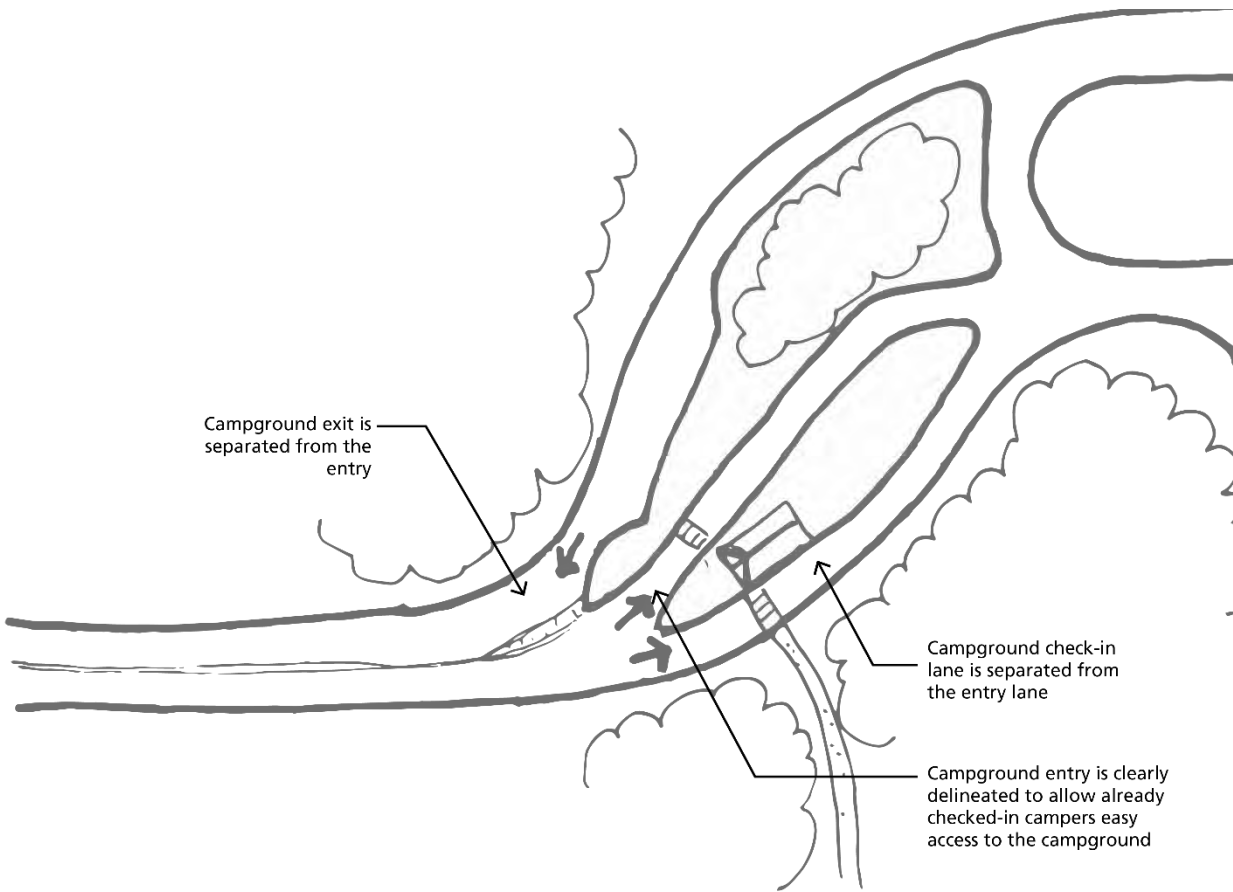

Figure 3.1 Acadia National Park, Maine, Blackwoods Campground entry plan provides space for check-in, easy access for already checked-in campers, and a clear exit.



Figure 3.2 The Blackwoods Campground check-in area with a building that represents the park architectural vernacular.

In smaller campgrounds, or for after-hour arrival in large campgrounds, a **fee-kiosk with a bulletin board** and iron-ranger (fee deposit box) can provide the correct information for visitors without the need for park staff. The area should be a pull off located near the campground entrance, before campsites, and should be clearly marked. Park pull offs should be sized appropriately for multiple vehicles and should consider the types of vehicles expected (i.e., if the campground accommodates large RVs, then the pull off should also have room for several parked RVs). The bulletin board should have a map of the campground, showing where campsites and services are located, campground regulations, and how visitors pay camping fees. Typically, envelopes where visitors fill out their information and insert the camping fee are provided to then be dropped into the iron-ranger.

While iron rangers have a long tradition of use in parks, shifting away from the use of iron rangers and towards digital methods of fee collection is superior. Recreation.gov allows for easy cashless fee collection that is preferred by visitors and provides many benefits for parks. It is recommended that parks embrace Recreation.gov and shift away from cash fee collection. Use of recreation.gov can also be more accessible for persons with disabilities for registration. Recreation.gov can offer staggered reservation services, releasing some sites in advance while reserving some for more spontaneous travelers.

BUY YOUR PASS ONLINE RECREATION.gov PADRE ISLAND NATIONAL SEASHORE





Scan me

BUY YOUR PASS ONLINE

Enjoy the convenience of purchasing a Site Pass for **PADRE ISLAND NATIONAL SEASHORE** on **Recreation.gov** to cover entrance fees for your visit.



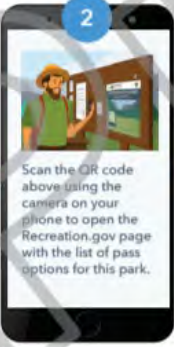

HOW TO BUY A SITE PASS

- 

Site passes provide access to a single recreation location. Site passes can be downloaded and used right from your phone.
- 

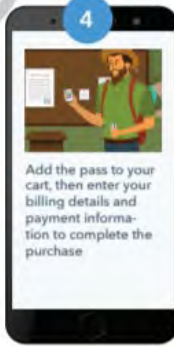
Scan the QR code above (using the camera on your phone) to open the Recreation.gov page with the list of pass options for this park.
- 

Select the best pass for your visit, fill in the pass details, and confirm you accept the important "Need to Know" information.
- 

Add the pass to your cart, then enter your billing details and payment information to complete the purchase.
- 

Site passes are immediately available for download and also sent to you via email. When asked for proof of payment, simply pull up your pass on your phone.

Find the right pass for you! Whether you're planning a single visit or coming back multiple times a year, you'll find the perfect pass for you on **Recreation.gov**.

Figure 3.3 A Recreation.gov instruction page shows how to buy a pass online.



Figure 3.4 Close-up of an example of a Recreation.gov QR code for purchasing a site pass to Whiskeytown National Recreation Area.



Figure 1.5 Yellowstone National Park, Norris Campground arrival board allows visitors to see which campsites are occupied and available. The accessible campsites are delineated by an accessible symbol.



Figure 3.6 Glacier National Park self-registration campground kiosk.

Accessibility. If an iron ranger, or fee deposit box, is used, place it near the bulletin board. Position the slot where fees are deposited no higher than 48 inches high. Locate a lock gate chamber opening on the back side of the iron ranger 24 inches above the ground, which will allow park staff to collect all fees. For additional information about reach ranges, see [ABAAS Chapter 308](#).

Provide a minimum clear ground space of 30 inches by 48 inches in front of the bulletin board and fee deposit box, with a level ground surface with slopes not exceeding two percent (See [Chapter 10 of ABAAS](#).)

Accessibility must be provided at all arrival facilities. See: Accessibility approach – [ABAAS sections 401–406](#).

Vehicular Arrival

Most visitors arrive at a campground by private vehicle. This can include a single family vehicle with tent, single family vehicle with trailer, multi-family/extended family groups, RV, and groups in multiple vehicles.

The United States Forest Service provides guidance on fee stations and campground arrival in their US Forest Service [FSH 2309.13 Recreation Site Handbook](#). Some key features of that guidance follow.

Provide for adequate queuing at campground or fee site entrances to avoid vehicles stopping along access roads or highways.

- Make sure the entrance road to a campground area is nearly level with the primary road so that maximum safety and minimum grading can be achieved. It is recommended that the entrance station be located on the road that leads into the recreation area and at least 150 feet off the primary road. Busy or larger campgrounds will need additional queuing distances.
- Consider a design that combines the contact station and the site office into one building where those two functions occur in the same area. All new or rehabilitated entrance areas must be accessible and may include the following features:
 - At least two incoming traffic lanes. One lane can be a bypass for registered campers with one for in-bound campers.
 - Parking spaces for at least two cars, one of which must be a van-accessible parking space.
 - A self-service fee depository.
 - Vehicular turnaround space both inside and outside the entrance station.
 - An outgoing traffic lane.
 - Provide adequate space for large RVs, trailers, and/or boats depending on the services provided at the campground and park.

To enhance efficiency of administration, design developed recreation sites with a single entrance. Design to minimize unnecessary operation and maintenance travel, and where feasible, provide an alternate egress route that could be used if rapid evacuation of the site is required.



Figure 3.7 Yosemite National Park campground reservation office.

Alternate Arrival Considerations

It is important to consider different means of visitors arriving at a campground or park. Public transportation, ride sharing, and bicycles are all increasingly popular ways to visit NPS sites.

More information on alternative and innovative transportation can be found here:

- <https://www.nps.gov/subjects/transportation/alternative-transportation.htm>
- https://www.nps.gov/subjects/transportation/upload/Program_Fact_Sheet_Innovation_19_0930_508.pdf

Having a designated bus and ride/sharing drop-off, as well as a designated bike parking area, will allow the park to concentrate visitor use to a specific location and direct visitors, **through proper trails** and outdoor recreation access routes, to the fee kiosk, campground, or other services. Visitors arriving on bike packing or hiking trips often rely on the availability of biker/hiker campsites. Make considerations to ease wayfinding for persons with vision impairments. This can be accomplished in a variety of ways such as using GPS, color-coded trails, or tactile maps.

Bus and Ride Share Drop-Off

The following are guidelines are for bus drop-off zones:

- Ensure bus lanes are a minimum of 11 feet wide.
- Consider 50 feet turning radius for buses.
- Place bus shelters parallel to the curb, and ensure that there is a six-foot clear pedestrian path adjacent to the shelter, at a minimum, to allow pedestrians to travel around the shelter. A bus shelter should be 10 feet high, and the overhang of the roof should be located two feet or more from the curb.

- Provide eight feet by eight feet ground clearance adjacent to the curb for a wheelchair landing and loading space.
- Locate pedestrian crosswalks within clear sight lines of vehicular traffic.
- Provide benches, trash and recycling, and wayfinding signage at the bus drop-off.
- Provide real-time passenger information in both audio and visual formats when possible. If real-time is not available, post bus schedules and other contact information for ride-share or public transit. Provide alternative formats for people with disabilities.



Figure 3.8 A shuttle stop at Moraine Campground in Rocky Mountain National Park services the Bear Lake corridor.

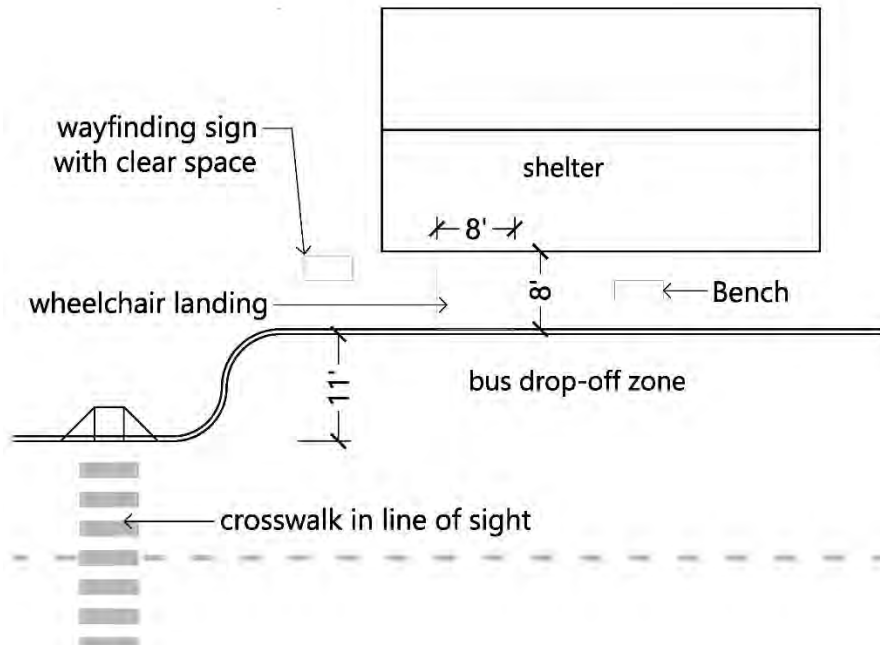

Figure 3.9 Bus and Ride Share Drop-off Dimensions should meet ABAAS requirements as noted above.

Bicycle Facilities

Reference the [National Park Service Active Transportation Guidebook](#) for resources on walking and bicycling in national parks.

- Make sure bicycle lanes adjacent to low speed roads are a four-foot minimum; a six-foot width is preferred.
- Design bikeways to be a direct and convenient connection between trails, campgrounds, and other services.
- Provide a bicycle dismount zone where bicyclists can transition from the bike trail to pedestrian sidewalks and walk their bikes to the designated bicycle parking area.
- Provide bicycle parking spaces, which could include bicycle lockers for long-term bicycle parking.
- Refer to [AASHTO Guide for Developing Bicycle Facilities](#), Chapter 4, Design of On-Road Facilities for detailed information.
- Adventure Cycling also provides biking and camping guidance in their [Guide to Bicycle Camping](#).

The following are bicycle rack placement and overall specifications from the [AASHTO Guide for Developing Bicycle Facilities](#), Section 6.3.1 and 6.3.2.

- Place rack units aligned end-to-end a minimum of 96 inches apart.
- Place rack units aligned side-by-side a minimum of 36 inches apart.
- Support the bicycle at two points above its center of gravity.
- Accommodate high security, U-shaped bike locks.
- Accommodate locks securing the frame and one or both wheels (preferably without removing the front wheel from the bicycle).
- Provide adequate distance (minimum of 36 inches) between spaces so that bicycles do not interfere with each other.
- Do not contain protruding elements or sharp edges.
- Do not bend wheels or damage bicycle parts.
- Do not make the user lift the bicycle off the ground.



Figure 3.10 Grand Canyon National Park bicycle rental and café.



Figure 3.11 Large boulders with drilled metal rings are used as a unique bike rack in a natural setting.



Figure 3.12 Consider adding a fixed bike tool stand like this one at a park in Jefferson County Colorado. The photo on the right shows a close up of tools attached to cables. The stand also includes a tire pump.

SIGNAGE

Signs are an integral built feature within a campground as the primary way the National Park Service communicates with park visitors. Not only do signs provide the regulatory or enforceable requirements within a campground, but they also provide directional or wayfinding information, safety/warning, identity informational guidance and interpretive information. Consider signs within a campground as an integrated system even though each sign has a specific function within the campground. When combined the signs enhance the visitor experience by delivering information. To increase efficiency and reduce sign fatigue (too many signs), develop a campground sign plan to identify sign layout and messages.

The design of the signs may vary slightly from park to park, specifically with the parks that already have a sign standard developed. However, parks should consult with the [National Park Service Sign Program](#), located at the Harpers Ferry Center prior to beginning a sign plan. This program helps establish the National Park Service's identity through developing and maintaining sign standards. The NPS Sign Program has three main categories for signs: Identity (entrance signs), Motorist Guidance (Road signs), and VIS (Visitor Information System). The VIS signs are the regulations, entrance fees, trailheads, trail directions, warnings, restrooms, campsite numbers, etc. Consulting with this program prior to updating park signs in campgrounds will save parks time and money by utilizing standards already developed and most importantly provide signs that are consistent across the service. See [Director's Order 52C](#) and [Sign Program SharePoint](#).

Visitors who travel from park to park are greeted by a graphic language that they come to know and understand. Communication is more assured, more rapid, and more effective. Furthermore, . . .visitors are reminded that individual parks are part of a larger organization with common practices and shared purposes.

https://www.nps.gov/policy/DOrders/DO_52C.pdf

A campground can often become "littered" with signs. This creates sign fatigue (too many signs) for a visitor and can sometimes render signs to be ineffective because the visitor stops reading them. A campground sign plan can greatly reduce the number of signs and aid in generating a more efficient message, one that can often convey several pieces of information at one time. Additionally, a campground that is part of a cultural landscape and/or historic district may have signs that contribute to that cultural landscape and/or district with design character (e.g., materials, lettering, size, orientation) that can be maintained and can inform additional compatible design interventions as needed to maintain the visual quality of the campground. Many historic lettering sizes, colors and styles can be difficult for persons with visual impairments. Supplement such signs with others that are more easily readable or through technology.

Owens Creek Campground Map

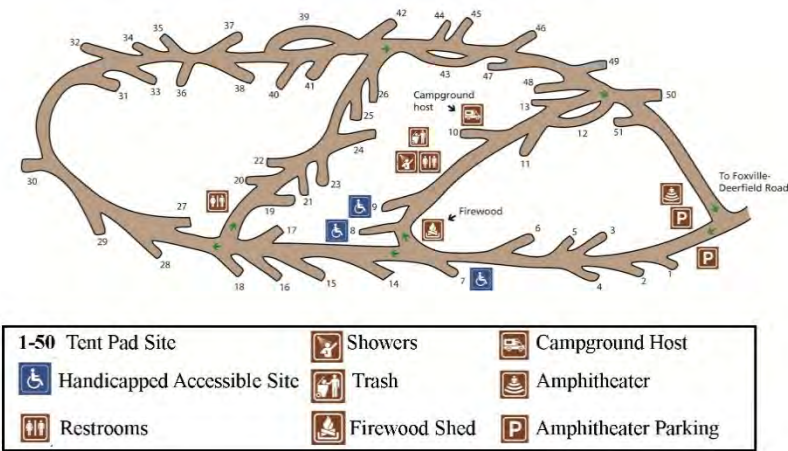

Figure 3.13 Catoctin Mountain Park, Owens Creek Campground Map uses symbols to convey locations of campground services.

Accessibility. Signs are covered by the [Architectural Barriers Act](#). Specific scoping information related to signs can be found under [Scoping F216 and technical requirements in ABAAS Chapter 7](#). Prior to developing signs accessibility requirements must be included.

Harpers Ferry Center has resources available for NPS specific [accessibility guidelines](#) related to publications, exhibits, audiovisual programs and tours, wayside exhibits, signage, and web-based media.

REGULATORY SIGNAGE AND PAVEMENT MARKINGS

Operations and Maintenance Considerations

Minimize the use of numerous colors in pavement markings. This reduces the need to clean the spray machine between the changing of colors.

Minimize and consolidate signs as feasible to reduce sign fatigue and future maintenance.

[text in call out box, or other graphic text effect]

Regulatory signs and pavement markings in campgrounds are used to inform visitors of campground regulatory requirements—these are regulations enforceable by law. They indicate requirements such as a speed limit, parking space, required fee, or other. These can be found in the park compendium or the Code of Federal Regulations. Include regulatory signs in the overall sign plan and use only to the extent necessary to clearly communicate regulations but not become a visual distraction.

The FHWA [Manual on Uniform Traffic Control Devices \(MUTCD\)](#), latest edition defines the standards for signs and pavement markings for both bicycle and pedestrian infrastructure and is routinely used for guidance related to proper application, installation, and maintenance of traffic

control devices on all public streets, highways, bikeways, and private roads open to public travel. In general, practitioners follow the MUTCD, or state specific MUTCD versions, whenever practicable unless there is a reason to deviate from established policy. Designers have discretion to use a formal design exception to use for example, smaller or fewer signs than recommended in the MUTCD. A memorandum of understanding between the NPS and the FHWA, updated in 2006, states that on campground roadways and other similar low-speed, low-volume roadways, signs may differ from the MUTCD if the National Park Service submits these signs under the experimental rules set forth in the MUTCD and obtains FHWA approval prior to their initial use. Contact a regional Federal Lands Transportation Program (FLTP) Manager for more information.

Pavement Markings

Pavement markings are a relatively low cost and important component in a campground. When used effectively, these markings can provide valuable information without the need for a vertical sign. The markings include accessible spaces and associated aisles, check-in lanes, no parking areas, RV check-in measurements, and more.

When possible, minimize the use of numerous colors in one area such as red no parking, yellow loading, and white parking space lines. Use of multiple colors may be unavoidable, however, as a maintenance enhancement look for opportunities to use a single color for marking curbs and other reserved areas. Some states and counties have specific pavement marking requirements and parks may choose to follow those requirements to maintain consistency in a region or state.



Figure 3.14 Striping in many different colors is visually unattractive and requires more maintenance.



Figure 3.15 Accessible parking space with white parking and white aisle.

Other Signs

Additionally, the National Park Service Sign Program, located at the Harpers Ferry Center, has National Park Service specific sign examples that can be updated/alterd for park needs. These may be signs specific to fee collection, administrative parking, or a myriad of other campground specific requirements. Recreation One Stop is working with Harpers Ferry Center to provide the basic elements needed to promote and use QR codes for camping, on site payments, etc. This will create a consistent design approach for parks in the future.

[\(HFC sign standards\)](#)



Figure 3.16 Examples of signs designed by the National Park Service Sign Program.

Rocky Mountain National Park	
Entrance Fees <i>(Valid for 7 Days with Receipt)</i>	
Private Vehicle	\$20
Motorcycle	\$15
Per Person <i>(Walk-in, Bicycle)</i>	\$4
Groups	Inquire
Annual Passes	
Rocky Mountain National Park	\$35
Interagency <i>(Multiple Federal Fee Areas)</i>	\$80
Lifetime Passes <i>(U.S. Citizens / Permanent Residents)</i>	
Interagency Senior <i>(Age 62+)</i>	\$10
Interagency Access <i>(Permanently Disabled)</i>	Free
Optional for Other Fees	
Option 1	\$25
Option 2	\$40

Figure 3.17 US Fee Area sign can be obtained through the NPS central Warehouse. http://surveyssupplyfleet.nps.gov/prjInventory_Local/cat/sc29b.htm

[add link to sample sign file resources]

EMERGENCY MANAGEMENT OR WARNING SIGNS

Where needed, sign appropriate emergency evacuation routes, clinics, or other emergency related information. The importance of these lifesaving signs cannot be understated. For additional information and to understand where and how these signs are needed, consult your park or regional Safety Officer and the local town and county Emergency Preparedness Plan. Guidance for Emergency Management related signs can be found within the [Manual of Uniform Traffic Control Devices](#) under Emergency Management Signing. Other similar emergency management and warning sign examples can also be located on the [National Park Service Sign Program](#) website.



EM-1a



Figure 3.18 Examples of warning signs specific to the National Park Service.

MOTORIST GUIDANCE AND PEDESTRIAN WAYFINDING

The elements of wayfinding are a series of visual, editorial, and environmental cues to help visitors navigate and experience a national park without confusion and conflict. The cues must enhance a visitor’s enjoyment and understanding of the park without damaging the park’s rich natural and cultural resources. Wayfinding refers to information in the physical environment that helps guide people between places. Wayfinding can be signs, arrows painted on the ground, physical barriers along a path, graphics on a wall, and more. These signs are considered a key aspect of a meaningful and more desirable park or campground experience. There are several important directional or wayfinding signs within a campground, and some of the types are detailed below.

Motorist Guidance

Key components include speed limit, arrows and symbols, and, if needed, a simple and clear message. Standard symbols are key to unifying National Park Service signage.



Figure 3.19 Examples of motorist guidance signage.

Pedestrian Wayfinding

Key components include arrows and symbols, and, if needed, a simple and clear message. Provide wayfinding at key intersections or areas of frequent visitor confusion. Tactile wayfinding is required for persons with disabilities.



Figure 3.20 Examples of pedestrian wayfinding signage.

Campsite Loops

Campground loops should contain the name of the loop and the range of sites available within that loop. Consider naming loops after place names from local cultural or natural history or flora/fauna commonly found in the national park. Ensure the loop signs are clearly visible to vehicles and easy to understand for all visitors, including those with limited English.

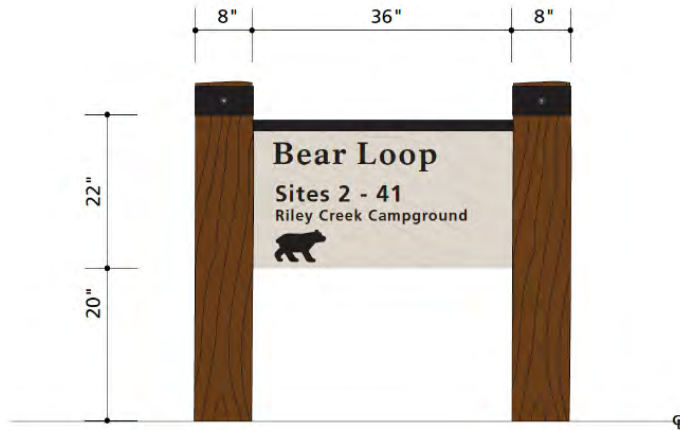

Figure 3.21 Campground loop sign example.

Individual campsite numbers. Each campsite should have its own distinguished number from other campsites and be labeled in sequential order in the primary direction of vehicle arrival. Many campgrounds label occupied campsites by clipping a paid slip to the campsite number post or carsonite post. Consider using reflective markings for nighttime navigation. Make the maximum sign height 48 inches to improve accessibility in all sites. Ensure that there is a location to fasten the clips if a campsite is managed in this manner.



Figure 3.22 Example of an individual campsite number.



Figure 3.23 Kenai Fjords National Park, Exit Glacier Campground, accessible campsite label.

Advanced notification of campground location, capacity, etc. Campgrounds can often avoid congestion within the campground if the status of the campground (open, closed, or full) is identified at a critical decision-making location. This can be at a turn off to the campground, an entrance station, or anywhere else visitors need status information. If this sign is manual, it will require personnel to update the status on a frequent basis.

INFORMATIONAL SIGNS

Check-in Procedure and General Campground Rules

These signs contain pertinent campground-related information with a campground map, regulations, check-in information, and more. This is particularly important for late check-ins or visitors arriving after the check-in is closed. Providing a tactile map (preferably portable) for blind visitors will allow familiarization with campground layout, including the relationships of individual campsites and facilities such as comfort stations and amphitheaters. (These can be inexpensively made using 3D printers.) In addition, include information on the park website that could be linked on-site using a QR code.



Figure 3.24 Example of fee, registration, and regulation information for a campground.

Trailhead Examples

Some campgrounds provide access to trails or trail systems. Ensure trailhead signs include accessibility information so that visitors can determine their ability to access the area.

Baseline Requirements for Trailhead Signage

1. Length of the trail or trail segment
2. Surface type
3. Typical and minimum tread width
4. Typical and maximum running slope
5. Typical and maximum cross slope

Accessibility.

F216.13 Trailhead Signs. Where new trail information signs are provided at trailheads on newly constructed or altered trails designed for use by hikers or pedestrians, the signs shall comply with 1017.10.

Advisory F216.13 Trailhead Signs. New trail information signs are required to comply with 1017.10 regardless of whether the newly constructed or altered trails comply with 1017. If trail information signs designate the name of the trail, only the name of the trail is required to comply with 703.5. (See

F216.2) Tactile characters are not required on exterior signs. Trail information signs are not required to display the International Symbol of Accessibility.

1017.10 Trailhead Signs. Trail information signs at trailheads shall include: (1) Length of the trail or trail segment; (2) Surface type; (3) Typical and minimum tread width; (4) Typical and maximum running slope; and (5) Typical and maximum cross slope.



Figure 3.25 To date, this example is the most comprehensive approach to effectively communicate trailhead information. Information is delivered multi-modally. The upright panel provides information visually, while the horizontal panel provides the same information tactilely, with braille and textures to differentiate areas (Abraham Lincoln Birthplace trailhead panel, Harpers Ferry Center.)

Trail Access Data

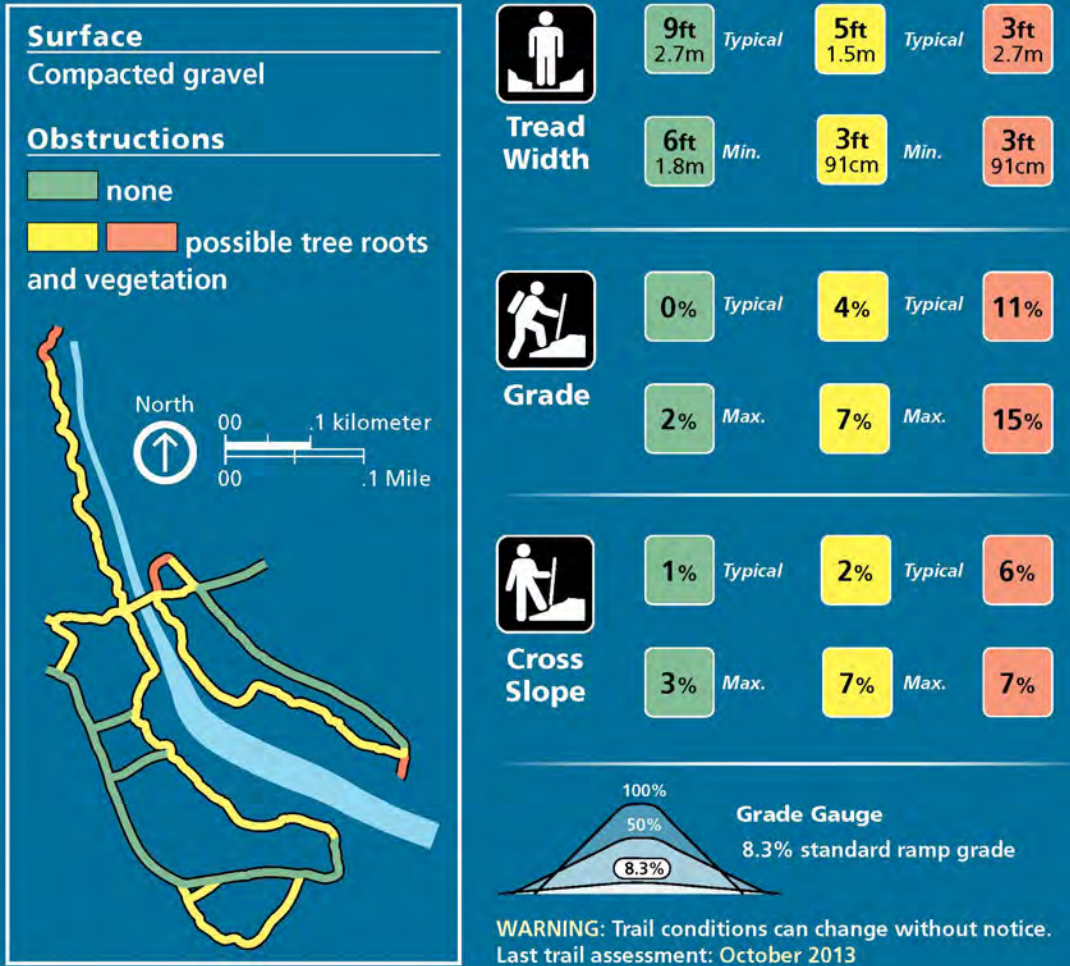

Figure 3.26 If trails have significant changes in grade or slope, representing this information through text and graphics may be helpful. Obstructions, such as tree roots, may also have an impact on a person's ability to use the trail. This information is conveyed through the map and color or texture. (Be careful on relying on color too much so as not to exclude persons with colorblindness.) Please note: the lengths of the trails are not listed because this information is provided in the interpretive wayside section of the upright panel.



Figure 3.27 Grand Canyon National Park, Hermit Road Greenway accessible trail sign.

Recycling Signs

Standardized signage on recycling /composting/ waste receptacles throughout the parks, as well as within the campgrounds, supports greater participation in the recycling program by directing visitors to collection locations. Recycle Across America is a great example of standardized labeling. Effective communication with visitors can significantly reduce visitor waste. Other areas such as at the campground that can provide information include check in, bulletin boards, inside comfort stations, and at the campsites.



Figure 3.28 Picnic table signs used at Grand Teton National Park.

CAMPGROUND ACCESS: ROADS, ROUTES, AND TRAILS

[Put following heading and bullets in a call out box or other graphic text effect.]

Operations and Maintenance Considerations

- Paved roadways and campsite parking are recommended where appropriate because of advantages related to accessible surface, consistent grade, delineation of space, dust control, durability, and maintenance.
- Ensure roadways have a proper place to drain such as a swale or detention basin or open area that will not become eroded by increased run-off.
- Consider storm water management, emergency vehicle, and waste removal operations when defining roadway widths and turning radii.
- Tree limb heights need to be considered for large vehicles.
- Follow sound engineering principles when constructing any roadway. For example, every road requires proper drainage and should be crowned or be angled slightly to shed water. Ditches, culverts, or swales may be required to facilitate runoff from storm events.
- Roadways are easiest to maintain if they are paved with asphalt, concrete, or other hardened surface.
- When paving a roadway, consider a safety edge. This assists drivers and cyclists and eliminates an abrupt edge that can often be a tripping hazard.
- Paving also minimizes routine grading required on gravel roads in tight areas and allows users with mobility issues to use roadways as an accessible route.

[Place above text in a call-out box or use other graphic text effect.]

ROADWAYS AND TRAILS

This section discusses motor vehicle, bicycle, and pedestrian access within campgrounds. It covers the roadway and the trails associated with the campground facility.

Campgrounds are often a part of a larger developed recreational facility (boating facility, lodging, visitor center, stores, etc.), and the roadways associated with these areas should have a distinct order

of hierarchy. Often, the main park road will lead to an arterial roadway that brings the visitor to a developed area with signs to direct the visitor to the campground via a collector road. The collector road is often considered the main campground road, which leads the visitor into and through the campground. Lastly, the local road will often consist of the campground loops that connect to individual campsites.

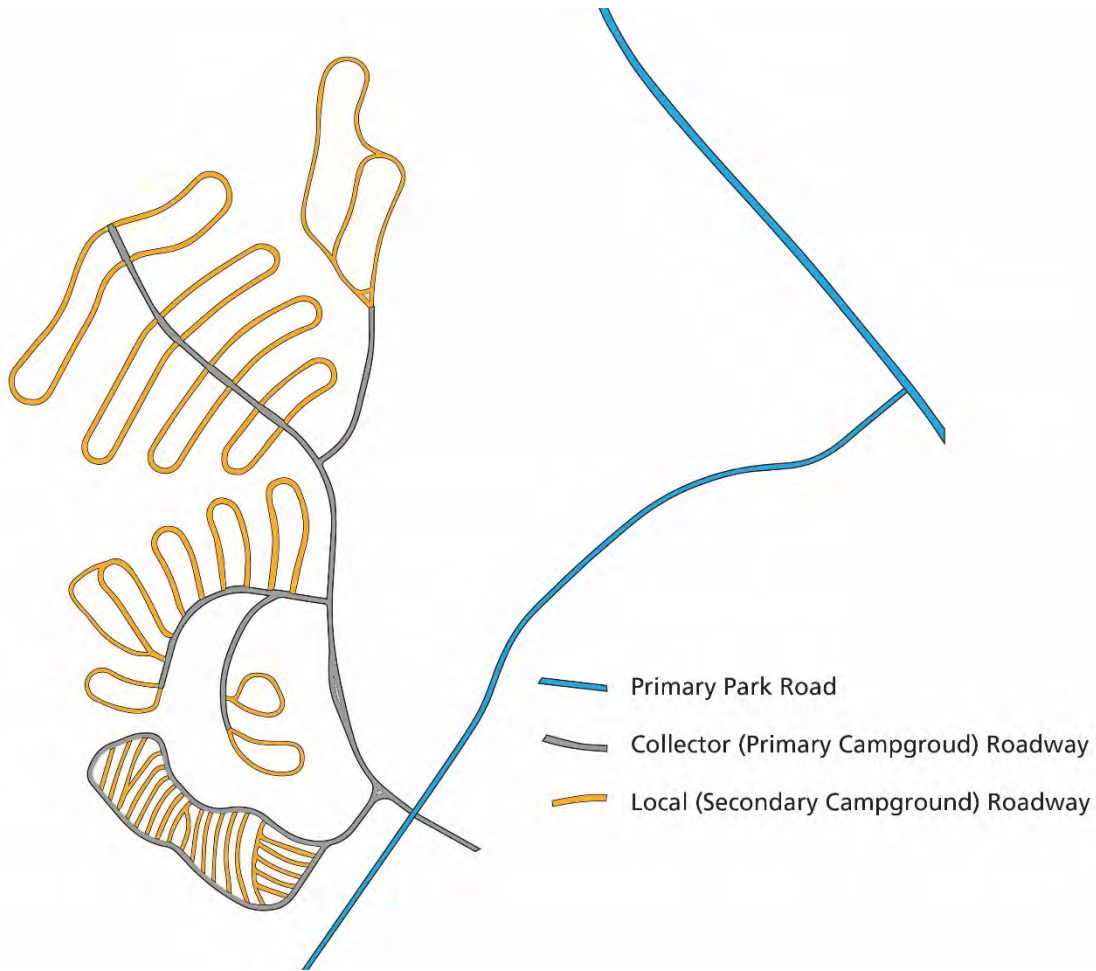

Figure 3.29 The hierarchical road system aids in wayfinding for visitors.





This hierarchical road system aids wayfinding for visitors and provides visual cues based on perceived road width, width of shoulder, and presence or lack of striping. This is especially important in large, densely wooded campgrounds, where sight lines are limited and loops may be confusing. This is also a passive transportation design technique used to control vehicular speed.



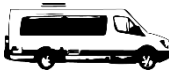

Much of what a driver perceives as roadway width relates to the road prism (widths of travel lanes + width of paved and unpaved shoulder + ditch and adjacent mowed area). Many times, travel lane width can remain consistent throughout a district and by adjusting the areas adjacent to the pavement edge; define the perceived hierarchy.

Roads designed for campground areas must provide adequate dimensions for the largest vehicle allowed and/or expected to use the campground or specific location within the campground. However, the general desire in most NPS campgrounds will be to design campground roads in a manner that requires a slower speed with less formal shoulder areas than may be found on the main park road.

Site characteristics will often dictate the level of standard used and each park must determine what size emergency vehicles (i.e., fire trucks), operational vehicles (i.e., garbage trucks), and recreational vehicles are allowed into each area. For instance, some park campgrounds may only allow RVs in one loop and plan to maintain all operational and emergency services on the collector roads. This would mean that the minimum roadway width and turning movement for these types of vehicles applies to the roads that allow that use. It is important to note that minimum standards are not always the recommended solution. The table below was adapted to include slightly larger radii than the minimum for each vehicle type. If feasible, apply an increased width and a larger, more accommodating turning radius. Additional room makes for an easier visitor driving experience, less resource damage, reduced maintenance, and greater future adaptability.

Additional resources can be found here: [FHWA resources for roadway planning and development. https://highways.dot.gov/sites/fhwa.dot.gov/files/docs/federal-lands/design/library/22006/park-road-std.pdf](https://highways.dot.gov/sites/fhwa.dot.gov/files/docs/federal-lands/design/library/22006/park-road-std.pdf)

Vehicle Image	Vehicle Type	Approx. length of vehicle type (feet)	Desired Turning Radius (inside) (feet)
	Single Vehicle, van, car, truck camper, etc.	12–18	25
	Truck with Fifth-Wheel Trailer	32–40 (trailer) + 10 (truck) = 50	50
	Type A Motorhome	25–40	50
	Type B Motorhome	18–24	30
	Type C Motorhome	20–31	35
	Travel Trailer	13–40	50

Vehicle Image	Vehicle Type	Approx. length of vehicle type (feet)	Desired Turning Radius (inside) (feet)
	Pop-up Camper Trailer	10–20	25
	Fire Truck - Large	40	50
	Paramedic Ambulance	–	30
	Large Garbage Truck	30 (38 with front extended)	40
	Large Plow Truck	40	45

Source: Primary reference material (Hopper 2007: 134). Most images expanded from KOA.

Figure 3.30 Vehicle type and important design information.

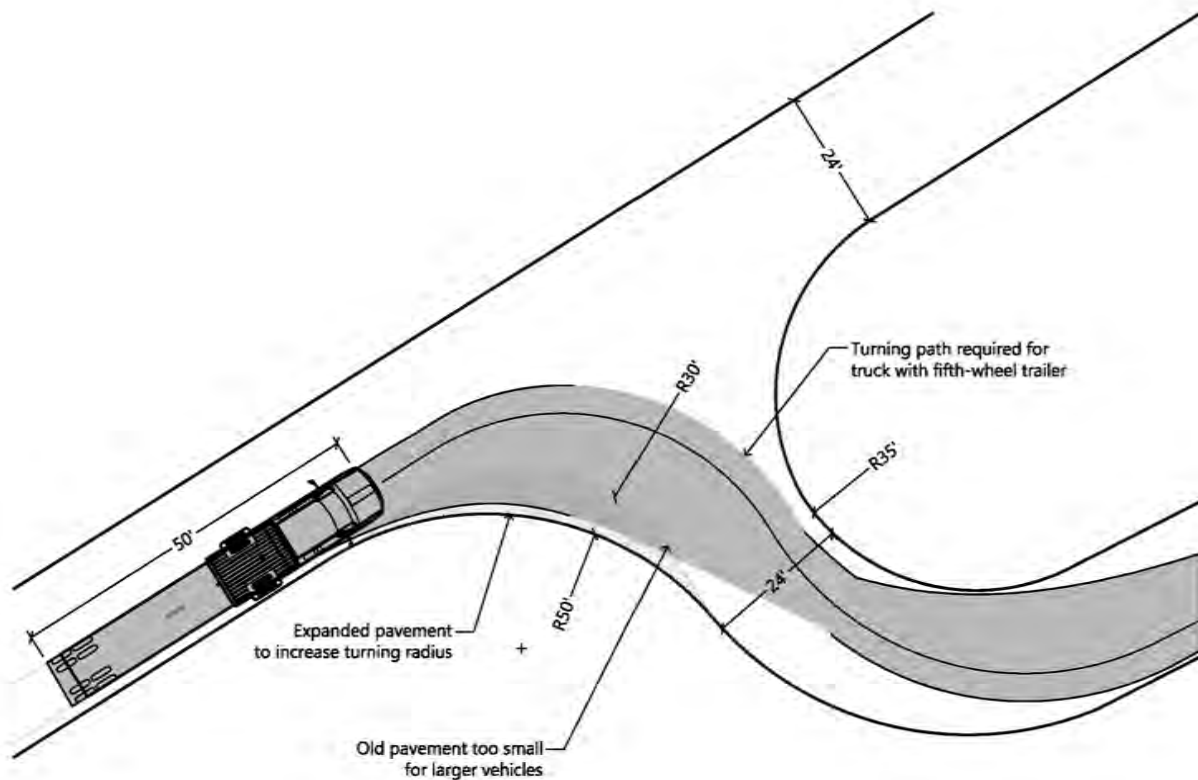
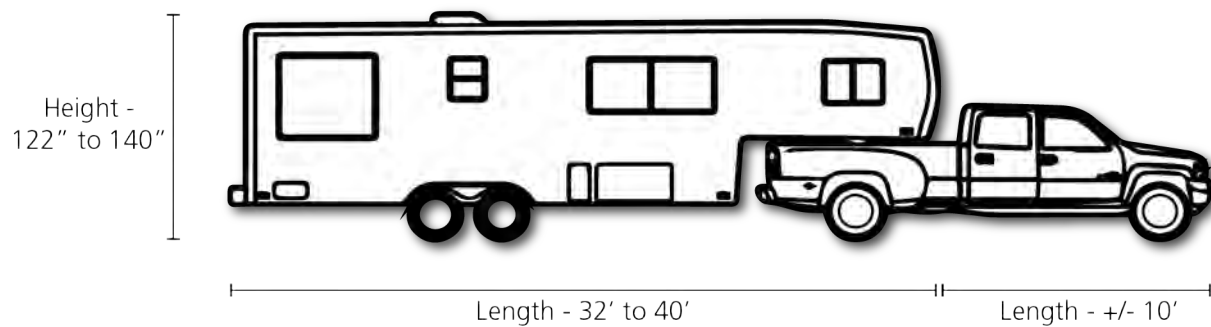
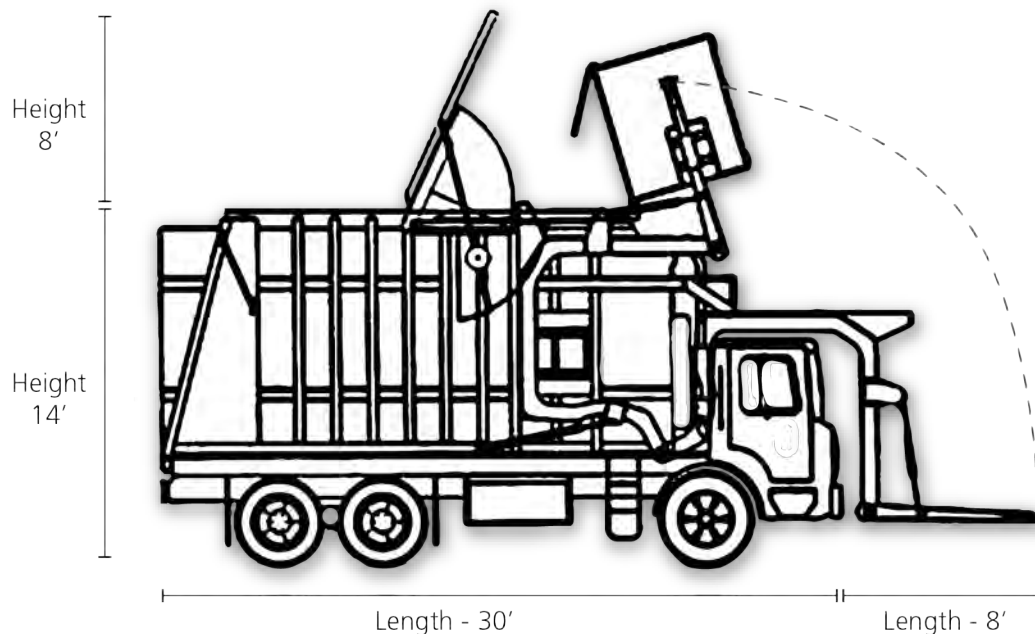

Figure 3.31 Larger radii are needed to accommodate larger vehicles. In situations where the roadway is narrow the curves will need to be widened or hardened with gravel to allow vehicles to make safe turning movements.



The total length of a fifth-wheel trailer can vary based on the model, but considering these dimensions can assist in roadway planning and design. The total height of trailers is also important because the tree canopy, telephone, and power lines, may be impacted by the height of these newer vehicles.



Dumpsters are common in campgrounds and require specific trucks to ensure they are emptied. The roadway must be designed to accommodate this maintenance equipment. Considering not only the turning radii, but the approach required to access the dumpster as well as the height of surrounding vertical objects are all important considerations in planning and design.



Figure 3.32 Section of Crowned Vehicular Road.

Collector (Primary Campground) Roadways

For the most part, the collector roadway should be two-way and have 12-foot-wide travel lanes (24-foot-wide minimum). This may be an increase in width from existing park road standards, and rehabilitation should be on a case-by case basis. Two-way roads provide the driver and pedestrian flexibility and reduce confusion caused by one-way roads. Roadways in campgrounds should never terminate without a large vehicle turnaround, which is important for both emergency vehicles and larger RVs. Pavement markings, such as a centerline, can be used to help visitors better understand the direction of travel. The roadway should have a low speed limit because pedestrians and many other user groups will often use these roadways.

Consider including a separate multiuse pathway or provide widened paved shoulders along the primary campground roadway. This will aid in pedestrian safety. Use the [AASHTO Guide for the Development of Bicycle Facilities \(2012\)](#) for all planning and construction efforts to determine the

appropriate solution for bicycles and pedestrians. The [National Park Service Active Transportation Guidebook](#) is another resource for supporting bicycles. ABAAS 1016, Outdoor Recreation Access Routes dictates requirements for accessibility.

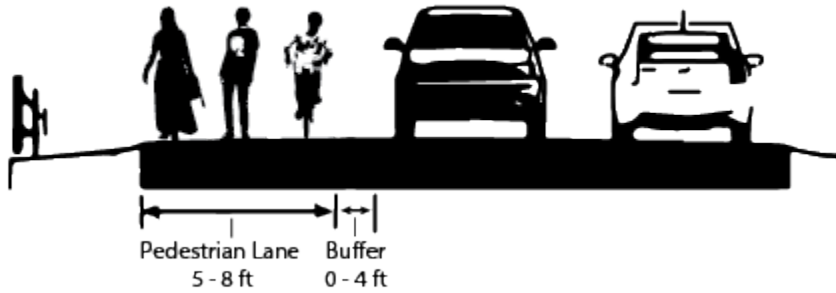

Figure 3.33 Section of Vehicular Road with Cars, Pedestrians, and Buffer.

Local (Secondary Campground) Roadways

Local or secondary campground roadways are often campground loops. These are typically one-way and should have a 12-foot-wide travel lane minimum. Secondary roads should be paved and designed to drain away from individual campsites. Radii at intersections should be based on the requirements of vehicles expected to use or service the campground. Corners and curves should be widened where feasible to allow for easier turning movements by large vehicles.

Adapting Existing Narrow Roadways

Many campgrounds were designed when smaller vehicles were the standard and existing roadways now may be too narrow for modern trucks and recreational vehicles (see [Historical Design section for historical widths](#)). When modernizing existing National Park Service campgrounds, make accommodations for contemporary vehicle requirements, where feasible.



Figure 3.34 Two images show a truck with a fifth-wheel trailer cutting over a radius that's too small in order to back into a campsite. In this case, a gravel buffer was added to extend the road width without additional asphalt. This assists the driver by providing a widened radius section and protects plant resources on the edge of the road.

Prior to adapting an existing roadway consider the following considerations:

- Understand physical site constraints.
- Understand any natural and cultural resource limitations to altering an existing campground.
- [Link to Pre-construction Considerations section.](#)
- [Link to Layout Design Considerations section](#)
- Determine what size emergency vehicles need to access the campground and how they will access campground facilities. Determine if the roadway can accommodate their activities.
- Understand maintenance operations, such as garbage collection, recycling, and solid waste removal. Define where each of these activities occurs and determine the vehicle size required to complete each activity. [Link Waste and Recycling section.](#)
- Understand and research state [RV size restrictions](#): [provide link to website with DOT links.](#)
 - Each state has the maximum allowable RV or travel trailer length. It is best to research the state allowances to determine what maximum length may be encountered within the state (this does not necessarily mean that the park allows this length of vehicle). In general, 45 feet is the average maximum single vehicle length.
 - Determine if the state allows the pulling of two trailers and the size restrictions. (For instance, a truck pulling a camper trailer and a boat.)
 - Determine the maximum height that is feasible in the campground. Many fifth-wheel trailers and Type A motorhomes are tall and may hit overhanging trees and low-hanging utilities.
- Understand that increasing the existing roadway width and turning movements will likely reduce or alter the number of existing campsites. It will also likely include lengthening the campsite parking areas and overall configurations.

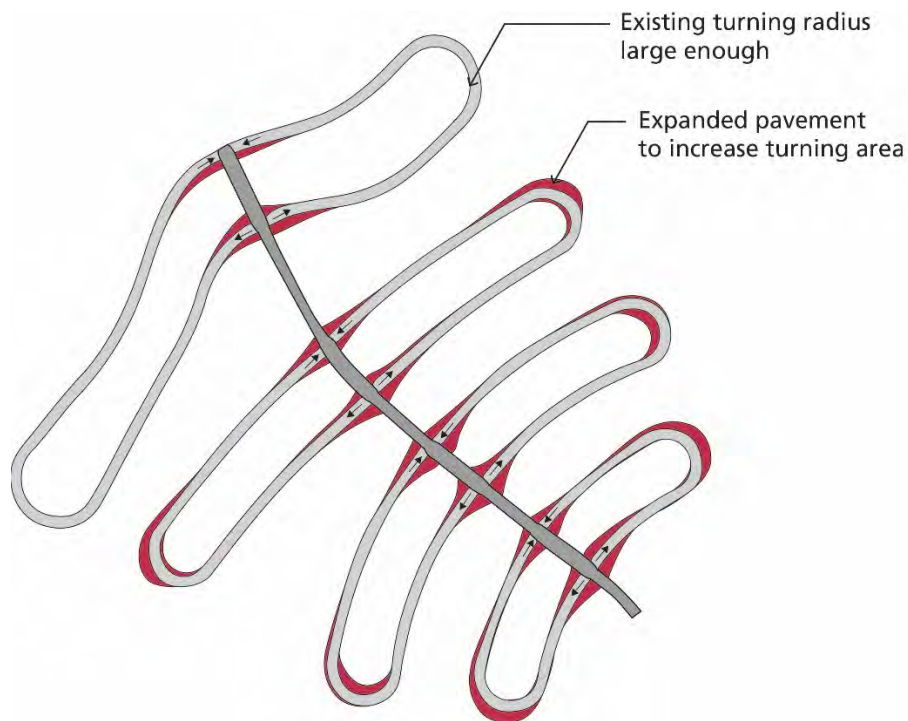

Figure 3.35 Existing one-way loops shown in gray. Expanded pavement shown in red provides additional area to accommodate larger turning radius. Additional area can be expanded on the outside or inside of a curve. An engineer will determine what is most feasible. Vehicle Barriers for Roadway Definition

Many National Park Service campgrounds experience vegetation and site damage caused by motor vehicles encroaching onto undisturbed areas. Over time the repeated damage creates a user defined area that is denuded of vegetation and can encourage other visitors to use the area. For this reason, vehicle barriers have been used for almost a century within the National Park Service. The location of the barrier to the roadway is dependent on many factors, but roadway speed plays a large role. The material type is largely dependent on the campground or park architectural character.

Key aspects of a successful vehicle barrier are:

1. Eliminates or deters a vehicle from using the protected area.
2. Blends into the site or meets the architectural character of a park, regional area, etc.
3. The built feature is long lasting and requires minimal maintenance for upkeep.

Boulders. Boulders are used frequently because the material blends in with the natural surroundings and is readily available. Partially bury boulders to appear grounded or as if they have always been there (with bedding planes in natural position). They can be used to prevent visitors from cutting corners or delineating short sections of roadway. Using boulders that are the same size and spaced the same distance can create a monotonous appearance and may defeat the purpose of using a material that is intended to blend into the natural setting. In areas where delineation is needed for a considerable length, consider low fencing or bollards, which are materials better suited for repetition.



Figure 3.36 Grand Canyon National Park, Arizona, Mather Campground, utilize local boulders to define parking within the campsite.



Figure 3.37 Great Smoky Mountains National Park, Tennessee, Elkmount Campground, utilize local boulders to define the roadway within the campground.

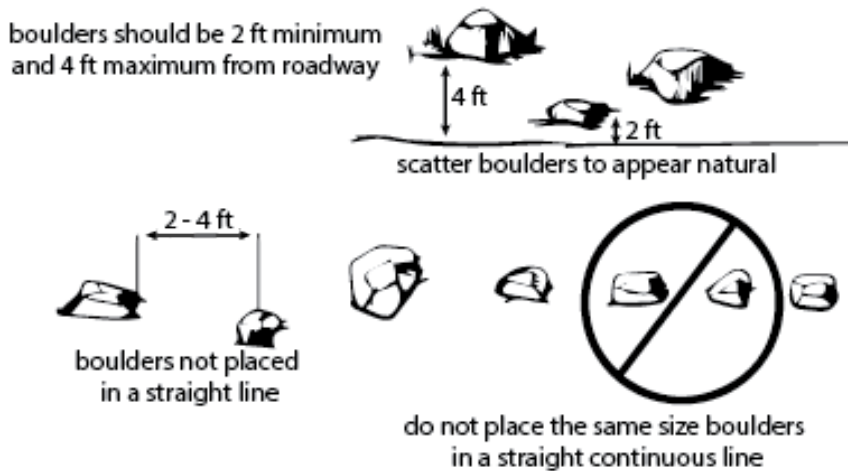

Figure 3.38 Boulder placement along roadways.

Large vegetation or berms. Vegetation and berms are often great vehicle barriers. Consider maintaining large trees or shrubs adjacent to the roadway (where operationally feasible) to deter vehicles from unwanted parking or driving. Berms create separation from roadways or campsites and delineate parking and roadway areas. For vegetation to be successful at discouraging visitor-created parking, it needs to be taller than five feet. The hoods of many trucks are more than four feet tall, and some drivers are not discouraged by vegetation unless they can see it above their hood.



Figure 3.39 A vegetated berm screens the campsite on the right from the entrance road on the left.



Figure 3.40 Rocks and vegetation screen individual campsites at Craters of the Moon National Park, Idaho, Lava Flow Campground.

Fencing or bollards. Fencing can also be used to separate parking and roadways or to discourage driving through natural areas. Materials vary (wood, metal, plastic) and should match park design guidelines or resource treatment plans.



Figure 3.41 Joshua Tree National Park, California, Ryan Campground, fencing helps to define pedestrian areas which is especially important in areas with limited vegetation.

Stone walls. In many parks, stone walls have become an architectural characteristic of the park or cultural landscape. In these areas, it is best to match existing stone walls (material and mortar). If stone walls are used, consider the maintenance of these structures. Many parks find that concrete structures with stone veneer are hard to maintain. Additionally, some walls are built with no structural support and can be undercut over time from site erosion. Despite some of the maintenance considerations, stone walls can be an ideal campground defining feature. Reference existing cultural landscape reports for treatment plans in historic campgrounds.



Figure 3.42 Buffalo National River, Arkansas, Buffalo Point Campground stone retaining wall.

CAMPGROUND PARKING

Parking areas that are not within individual campsites have the same requirements as parking lots elsewhere in the park. In general, make National Park Service parking spaces 10 feet wide and 20 feet long. This width allows trucks to open doors and visitors to more easily pull into a space.

Campground parking is separate from campsite parking and is beneficial at areas such as comfort stations, water hydrants, and fee stations.

- [See Pavement Markings](#) for parking area accessibility requirements.
- Many users arrive with two vehicles. Rather than limit these users to specific sites, consider adding parking for extra vehicles within each campground loop or in a central location.
- Parking at showers, laundry, and other key features is important, as these activities require additional supplies that many visitors may not want to carry by hand. Adding parking in these areas also increases accessibility for users of all abilities.
- Accessibility. The following [ABAAS F208, 406, 501-502](#) apply to general parking areas. Each parking area needs to be scoped separately so there is a van-accessible space at each type of parking lot.

Facility Type	Parking Space Per Site Feature
Walk-in Sites	1 space per campsite + accessible space requirement
Showers	1 space per 5 shower spaces + accessible space requirement
Laundry Facility	1 per 5 washers (IBC??) + accessible space requirement
Amphitheater	1 per 10 amphitheater seats + accessible space requirement
Entry Check-in	A minimum of 2 sites (one accessible), as feasible for demand
Day Use Picnic Area	1 per picnic table + accessible space requirement

CONNECTOR ROUTES AND TRAILS

Connector routes (trails) between campsites and comfort stations are important components of a campground. The trail width will vary depending on the number of users and the facility that it connects. Campsites generally experience social trails or visitor-created trails to comfort stations. As feasible, design site trails in locations that provide centralized access. Trails that are six to eight feet in width, have a firm and stable surface and located in a central location will entice more visitors to use and minimize social trailing. These primary trails are considered accessible routes and walking surfaces. Campground design should consider how users are moving through the entire campground without vehicles.

Accessibility

Specific to routes the following sections may apply depending on what services are linked: ([ABAAS F204, F206, 301-304, 307, 401-410, 504-505](#)). Also reference ABAAS, Chapter 10 for Outdoor Recreation Access Routes.



Figure 3.43 Six-foot-wide accessible crusher fine aggregate trail to comfort station. (Crusher fines can be accessible if compaction and slope requirements are maintained.)

Hiking and Horse Trails

Campgrounds are sometimes connected to larger trail networks. Consider **trailhead signs** and adjacent **parking** as necessary. These trails are often natural ground and roughly two feet wide (depending on use). Horse trails are generally natural ground and roughly three feet wide. Some accessibility requirements apply ([ABAAS F247](#), [ABAAS 1017](#)). Additional trail guidance includes [The Forest Service Trail Accessibility Guidelines \(FSTAG\)](#) and the [Forest Service Accessibility Guidebook for Outdoor Recreation and Trails](#).

Social Trails

Social trails, also known as user-created trails, are informal trails created by foot traffic. These paths often indicate preferred or more direct routes between destinations. These paths can be problematic and create erosion and unwanted ground disturbance. To avoid further damage, evaluate existing trail routes, identify where there are gaps, and formalize feasible social trails.

CAMPGROUND LAYOUTS

There are many things to consider when developing a campground. After determining the need for a campground, consider location first. Place a campground in a way that avoids both naturally and culturally sensitive resources. Locate campgrounds close to recreational opportunities for convenience and so that development is clustered. Design campgrounds as neighborhoods, where all services are easy to access from each campsite connected by **trails**, **signage** to orient visitors to services within and out of the campground, and simple **circulation** throughout the campground. Reduce stress for the driver by simplifying vehicular circulation, minimizing pedestrian conflicts, and accommodating the requirements of large vehicles by providing adequate space for turning, backing, and good overall visibility. Campgrounds or campground loops that are tent only can be designed for average-sized vehicles.

Vegetation. Vegetation plays a huge role in the atmosphere of a campground. Use native trees, shrubs, and perennials to enhance existing vegetation in-between each campsite to provide privacy and separation. Vegetation will also help delineate each campsite, making it clear where each site starts and ends. Depending on viewsheds and access to services, vegetation can be light to dense. In some instances, to minimize social trails or other unwanted visitor movement, the use of natural materials such as rocks can be used to define campsite spaces and access trails. Visitors will search for any available wood—whether dead and down or cut living—for use as firewood. Campgrounds may become denuded of vegetation if not carefully managed and education is not provided.

Waterfront sites. There are many campgrounds located on waterbodies, such as rivers, lakes, and streams. Depending on the water feature, campsites may be prone to flooding or other natural events, and it is important to design for this. Ensuring the resiliency of services that are provided will decrease maintenance costs over time such as using a waterproof facility or locating built amenities outside of typical flood areas. Waterfront sites may also invite visitors to launch boats directly from their site; consider providing a boat launch if this is not desirable.

LAYOUT DESIGN CONSIDERATIONS

The most common campground layout throughout the National Park Service is the loop layout. Functionality in the loop design has, over time, proved it to be an efficient campground layout. The loop layout can accommodate different campsite types in the same or separate loops and provide for separation of users but also group facilities such as comfort stations in central locations. A National Park Service Campground should use these design considerations for future layouts. The following list of considerations is intended to assist in both redeveloped and new campground layouts. Using the guidance will help designers maintain what has worked well in campground design while adapting to changing uses and technologies. Additionally, by using this list, a modern NPS campground can better maintain the historical design intent and mitigate potential adverse effects to a campground.

Vegetation

- Avoid sites with cultural or natural resource sensitivity, and protect native and culturally sensitive vegetation (including mature trees and shrubs).
- Relieve compaction and amend soils as needed before replanting.
- Revegetate denuded areas with native plants to screen each campsite.
- Arrange new plantings in arrangements that reflect natural or naturalistic patterns. Consider natural forest succession to ensure screening remains as trees and vegetation age.
- Screen campgrounds from park roads through plantings.
- Revegetate as part of construction to repair construction impacts and surround each campsite with screening vegetation.

Roads and Trails

- Retain character-defining features of existing campground roads and trails.
- Retain or apply Meinecke's layout of one-way loops/parking spurs in new campground design.
- Design of roads and access need to consider longer RVs, trash trucks, and emergency vehicles (including turning movements, pull-offs, parking spaces, etc.)
- Minimize impermeable paved surfaces to loop roads and parking spurs rather than campsites, which should be permeable. Nonpaved surfaces need to remain firm and stable for accessibility.
- Minimize use of extruded concrete curbs, mountable curbs, precast concrete bumper stops, etc., to reduce urban feel on naturalistic character. Understand that RV users may need a bumper cue to understand where to stop within a campsite space.
- Use gravel trails that are firm and stable in replacement of concrete trails. This trail surface blends in better with the natural environment and has a unique textural and sound quality.
- Align trails to connect campsites to common areas, key natural features, and other services using a curvilinear (rather than geometric) alignment.
- Delineate trails using stone, rock, or log edging to avoid social trail creation (and associated resource damage).
- Limit striping of asphalt pavement (e.g., fog-lines, parking spaces, no parking zones) to reduce visual intrusion on naturalistic character.

- Limit use of extruded concrete curbs, mountable curbs, precast concrete bumper stops, etc., to reduce visual intrusion on naturalistic character. Understand that RV users may need a bumper cue to understand where to stop within a campsite space.

Topography

- Retain and protect character-defining topographic features. Use natural topography of site to guide location of roads, campsites, buildings, services, and trails.
- Use topography to screen infrastructure (campsites, roads, trails, buildings).
- Use low rooflines, natural materials, and colors where appropriate to blend architecture with topography and surrounding landscape. [Potential graphic]
- Retain and protect character-defining topographic features.

Viewsheds

- Protect and enhance character-defining views and vistas for visitor viewing from campground common areas and individual campsites.
- Use key vistas and the creation of vistas to influence campground orientation and layout.
- Screen campgrounds and associated infrastructure from park roads.
- Protect and enhance character-defining views and vistas for visitor viewing from campground common areas and individual campsites.

Campsites

- Replace missing amenities/features of campsites to ensure each campsite has similar services to the same campsite type.
- Make furniture (picnic tables, cooking areas, tent pads, bear boxes) visually minimal but accessible to all people.
- Maintain relatively flat surface to reduce erosion and increase accessibility and camper comfort. Smaller RVs, camper vans, and car tents do not have vehicle leveling ability.
- Provide easy access to natural features of the park (e.g., trails, views, natural outcroppings, streams).
- Use natural delineators of stone, rock, or logs anchored into ground to prevent campsite enlargement and resource impacts.
- Be sensitive to the needs and the diversity of the visitor. Develop sites that meet the needs of those with physical limitations, parents with small children, and larger families.
- Meet the needs of special populations in campsites such as camp hosts, seasonal volunteers, SAR (Search and Rescue), and summer camp programs. For example, camp hosts are typically located at the entry of the campground and are provided utilities for long-term stays.
- Replace missing amenities/features of campsites to ensure each campsite has similar services as identified for new construction. Replace with a design style comparable to the existing or character-defining style of campground.

Buildings and Structures

- Repair and rehabilitate existing buildings and structures to retain their character-defining features, while updating with durable and maintainable products. Minimize the required footprint of new construction.
- Modify the design of existing buildings in a compatible manner that harmonizes with the original design.
- Use native and/or culturally sensitive and appropriate materials to the maximum extent possible.
- Use dark colors for materials/finishes to blend with the landscape: primarily browns/earth tones. Light colors may be required for desert landscapes.
- Use native or naturalistic materials for barriers such as rails, bumper stops, and edging.
- Anchor stone/rock edging materials by partially burying in the orientation that matches the natural bedding plane.
- Use low rooflines where climatically appropriate to minimize visual impact.
- Scale to match that of the landscape and total environment (e.g., large trees and features or large variations in topography can allow for larger, taller buildings and larger-scaled building materials).
- Repair and rehabilitate existing buildings and structures to retain their character-defining features, while updating with durable and maintainable products.
- Modify the design of existing buildings in a compatible manner that harmonizes with the original design.
- Find compatible uses for unused buildings and structures rather than remove them, if possible.

Fire Protection

- Build with fireproof materials (if possible) and upgrade historic wood shake roofs underlayment and roofing boards to meet fire requirements.
- Consider adding fire hydrants that can be used for structure, vehicle, and wildland fire fighting.
- Work with regional and park fire programs to establish Fire Management Plans to include campground protection and protection of cultural and natural resources located within existing campground.

CAMPSITE DISTRIBUTION IN A CAMPGROUND

Develop the distribution of campsite types within a campground using the [market analysis tools](#) described earlier in this guide and historical use data as it is available. See [Understanding the Visitor](#) section to find out how to gather information on visitor preferences, which can assist in determining the distribution of campsite types. However, if data is not available in general, consider a diverse distribution of campsite types. Equally distribute accessible sites among the different campsite types (RV, tent, group) and among different campsite experiences (wooded, open, near water). Make sure some accessible campsites are close to the comfort station, but quieter sites should also be accessible. Separate campsite types as much as possible. Separating the various campsite types will help reduce visitor conflicts and provide for a more enjoyable camping experience for all users. This can be accomplished by having different campground loops, with RV sites that allow generators in a loop

closest to the main park road and tent and walk-in sites located in a more secluded area. Group sites should also be separated from the other user groups.

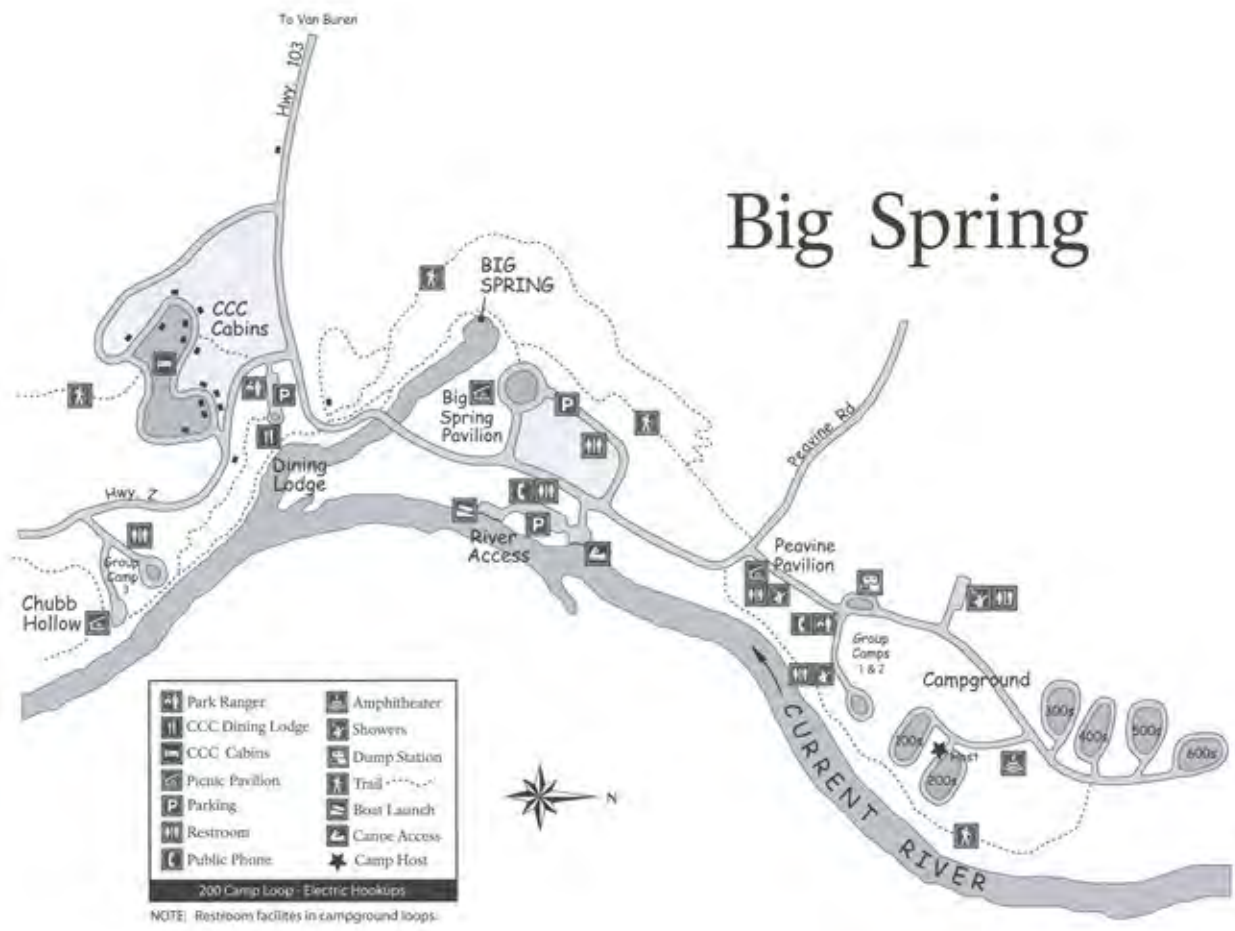

Figure 3.44 Ozark National Scenic Riverways, Missouri. Big Spring Campground map demonstrating numerous loops, trails, river, and spring access and on-site facilities.

CAMPSITE LAYOUTS

In a campground, there can be many different types of individual campsites. Depending on the visitor needs and purpose for visiting, these can vary from traditional tent-only sites, walk-in sites, RVs of varying sizes, equestrian users, boat-in, and more. To ensure appropriate amount of space between campsites, there should be between 11 and 15 campsites per acre.

The four most common types of campsite layouts in a developed campground include:

- **Vehicle and tent campsites.** These sites require roughly 3,000 square feet of space each, including parking and space between campsites.
- **Forty-five-foot length RV campsite.** The lengths allowed may vary in campgrounds. These sites require roughly 4,500 square feet of space, including parking.

- **Group sites.** These sites vary widely in size; assume roughly 1,000 square feet for 1 person. This includes parking, comfort stations, and group campsite features. Group loops accommodating more than 200 persons may have more condensed spaces available per person.
- **Walk-in or bike-in campsites.** These sites require roughly 2,000 square feet of space not including parking.

Each campsite living area should include a tent space such as a square **tent pad** made of compacted crusher fines or an area cleared of vegetation (sloped 1.5 percent to drain), parking space, **picnic table**, **fire ring**, and other **services**. The typical living area of a campsite should meet the following space recommendations for services:

- 16' x 16' or 12' x 18' level tent space
- 8' x 14' table and bench space
- 10.5' x 10.5' fire ring area

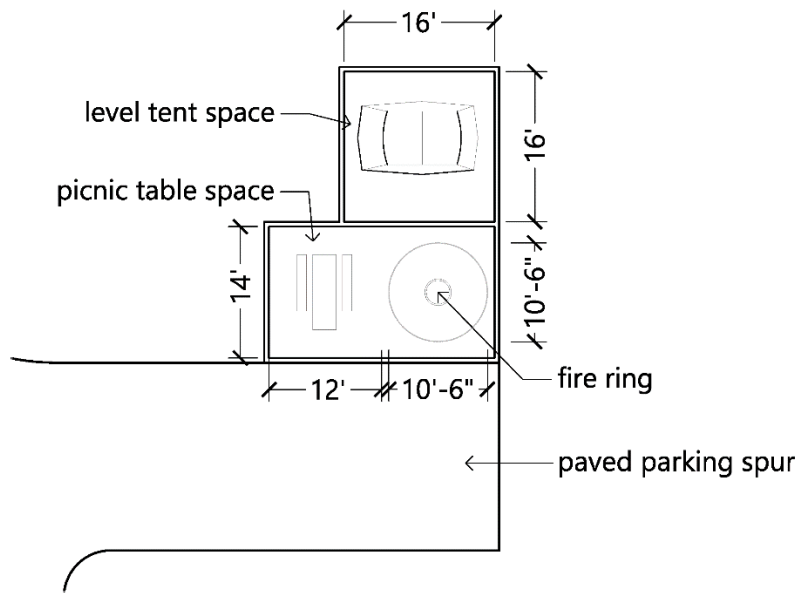

Figure 3.45 16' x 16' Campsite with tent pad, picnic table, fire ring, and paved parking spur.

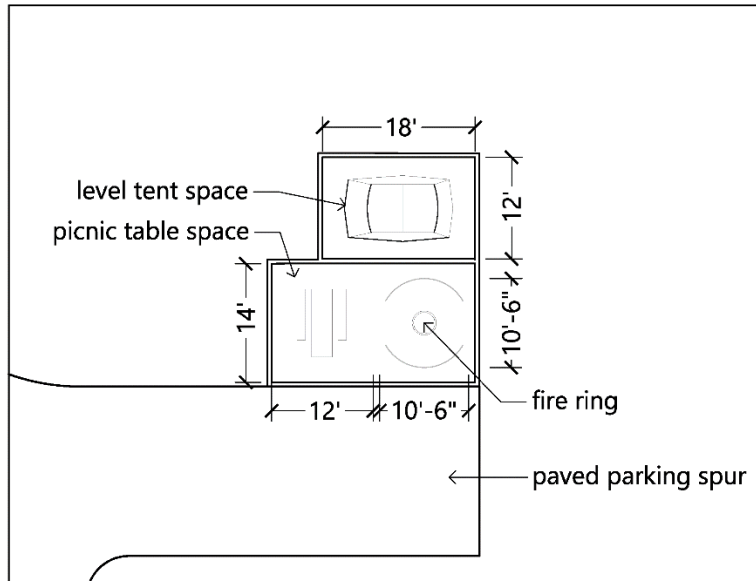

Figure 3.46 12' x 18' Campsite with tent pad, picnic table, fire ring, and paved parking spur.

CAMPSITE TYPES

Vehicle and Tent

For traditional vehicle and tent sites, a pull-through or back-in parking stall can be used. Small RV or sprinter van users typically use traditional car and tent campsites since the equipment size can fit in a car parking stall. For a pull-through campsite, allow for 100 feet between the pull-through entrance and exit, with a 50-degree radius arc of pavement. Ensure site space is 25 feet wide to accommodate a five-foot accessible aisle. For back-in campsites, ensure the site space is 50 feet in length and 20 feet wide, and between a 45-60 degree angle from the road.

Emerging trends also include roof-top tents for vehicles. Although these accommodations will fit in typical vehicle and tent sites, considerations are needed to ensure there is proper clearance height in the parking stall and the parking stall slope is level so the vehicle will be level when parked. Providing this campsite information, along with general services and campsite pictures, on reservation sites will allow visitors to ensure their preferred camping accommodations will fit in the campsite.

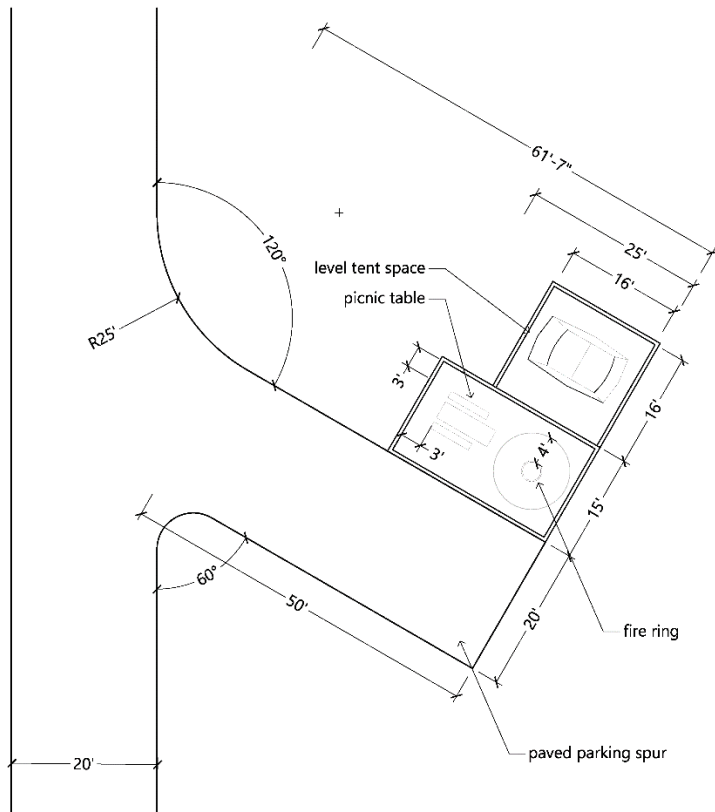

Figure 3.47 Accessible campsite with tent pad, picnic table, fire ring, and paved parking spur.

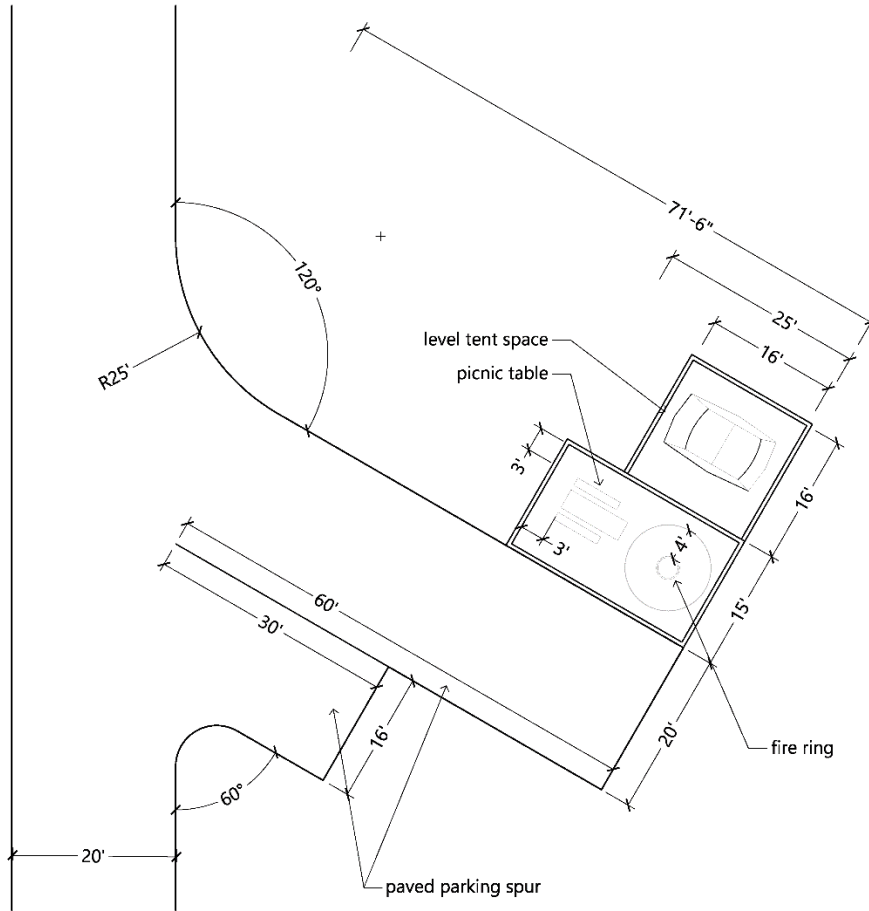

Figure 3.48 Accessible double campsite with tent pad, picnic table, fire ring, and two paved parking spurs.

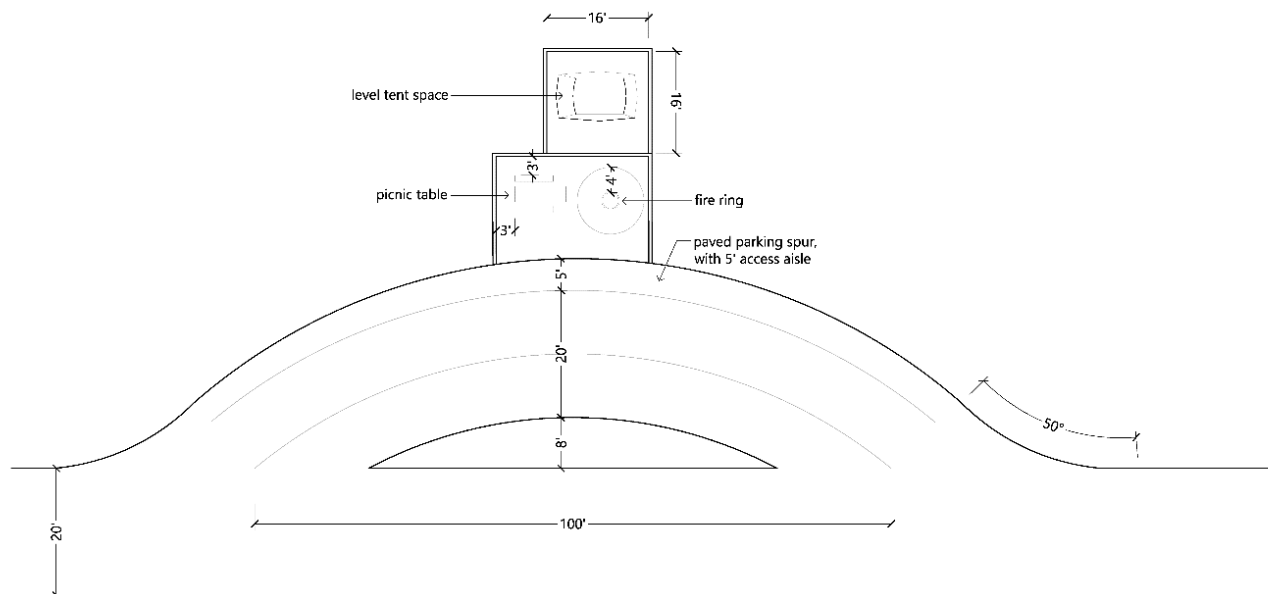

Figure 3.49 Accessible pull through campsite with tent pad, picnic table, fire ring, and paved parking spur.

Large RV and Trailers with Pop Outs

Larger RV sites are becoming increasingly popular among campground users. These large vehicles require additional parking space, and additional space for any towed vehicles, boats, etc. Pull-through spots are more favorable and easier to navigate but also require more room, so consider a mixture of pull-through and back-in. **Electric and water and wastewater hookups** can be provided as additional services; however, the park must consider their capacity to expand utilities to accommodate for this.

Common RV items to consider when designing RV campsites include:

- Water, sewer, and electrical hookups are typically on the driver side.
- Camper entry is typically on passenger side and/or back.
- Pop-outs, awnings etc. add width to parking stalls and can be on all sides.
- Consider how the vehicle will maneuver into the space in a way that allows the driver to see the hookup pedestals. Eliminate the situation that forces drivers to back into pedestals. If the access road is one-way, National Fire Protection Association (NFPA) required pedestals on

the driver side. If pedestals must be on passenger side, it is better to have a pull through campsite. Consider ease of drivability/practicality during layout of loop roads and campsites.

- Consider RV vehicle height to avoid tree damage. See **Vehicle/RV size table** and graphic.
- In campgrounds with small loops or where RV's are not allowed in every loop because of roadway constraints, sign each loop with the maximum length vehicle so that drivers know what to expect.
- All RV campsites (pull-through or back-in) will intersect roads at no less than a 45-degree angle and no more than a 60-degree angle for ease in maneuvering. Each site includes, at a minimum, a concrete or asphalt pad for RV and vehicle parking and an adjoining pad for outdoor living area (see diagrams for details).
- An individual RV campsite will be as flat as possible.
- Ensure parking spurs are a minimum of 40 feet wide if there is an existing cross slope of 0%-4% and 45 feet wide if the existing cross slope is greater than 4%.
- Ensure the minimum parking spur length is 75 feet to 80 feet for back-in and 80 feet to 100 feet for pull-through. **Existing longitudinal slopes in excess of 3%.**
- The cross slope for the RV parking spur will be less than 1%, preferably 0.5%.
- The longitudinal slope for the RV parking spur will be 2% or less.



Figure 3.50 Numerous camper pop outs add room to the interior of the camper but require additional space on the exterior.

Bicycle/Backpacker Sites/Walk-in Sites

Walk-in sites provide a more solitary camping experience, while still providing access to all the services provided in a developed campground. Parking stalls that are clearly marked with the corresponding walk-in campsite are provided along the campground road. If two vehicles per campsite are allowed throughout the campground, then provide two parking stalls for walk-in campsites, which could be accomplished through a nearby overflow parking lot within the campground. Provide an accessible [trail or outdoor recreation access route](#) connecting the parking space to their respective campsites. If the intent is to encourage bike-in camping, provide [bike parking stalls](#) close to each campsite.

If a park is a bicycle tourism destination, having bicycle-only campsites is critical. Bicyclists often travel long distances and end their journey at the park. Providing specific sites for these visitors is important. Bicyclists often travel light and require a smaller campsite footprint than typical car campers. Consider including services at bicycle campsites such as bike parking, bike repair station, storage lockers, electrical outlets, and showers. Reference the [Guide to Bicycle Camping](#) by Adventure Cycling Association for more specific information.

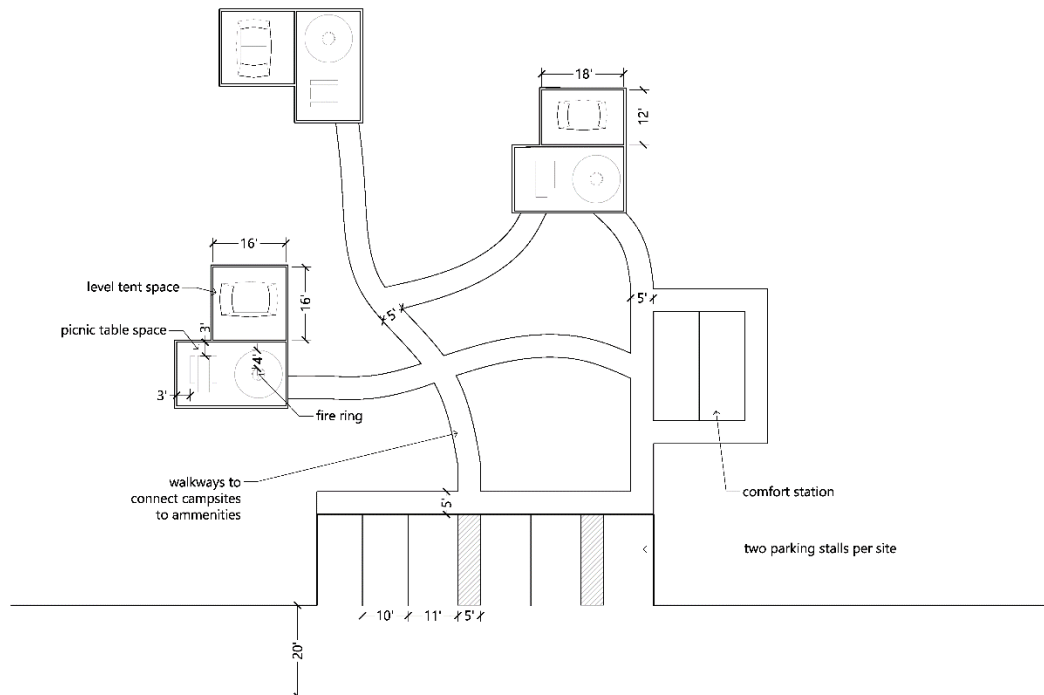

Figure 3.51 Accessible walk in campsite with parking stalls, walkways to three campsites, and a comfort station.

Equestrian Campsites

The US Forest Service has an excellent resource for equestrian campsites ([link to forest service guide](#)). The following are key considerations from the guide. Most equestrian campers prefer pull-through sites, as it is easier to navigate with a trailer in tow. Place campsite living area on the passenger side of the road, since most trailers have access on the passenger side. Back-in sites may be preferable since the horse trailer is farther from the road. Provide additional parking areas for additional vehicles and trailers.

Equestrian sites should provide amenities beyond basic campground services. These include a living area for the horses with horse tie-up posts away from the roadway. Ensure the horse area is somewhat level and there is proper shade during the heat of the day in these areas, either by vegetation or a shelter, and place the horse area downwind of the main camping area. Additionally, manure-specific collection areas are needed or signs indicating that visitors are to individually haul manure out of the park.

In equestrian campsites, vegetation management is very important, as some noxious weeds or native plants could be toxic to horses. Ensure park maintenance staff can identify toxic vegetation and know proper treatment. To avoid damage to vegetation, be sure to locate the horse area away from sensitive plants.

Maintenance consideration. Generally, the finer the surface material, the easier horse manure can be removed. Suitable materials include wood chips and shavings, loose aggregate, pea gravel, and soil. Usually the most economical and effective surface material for living areas is compacted, crushed aggregate with smaller fine material to help hold it together.

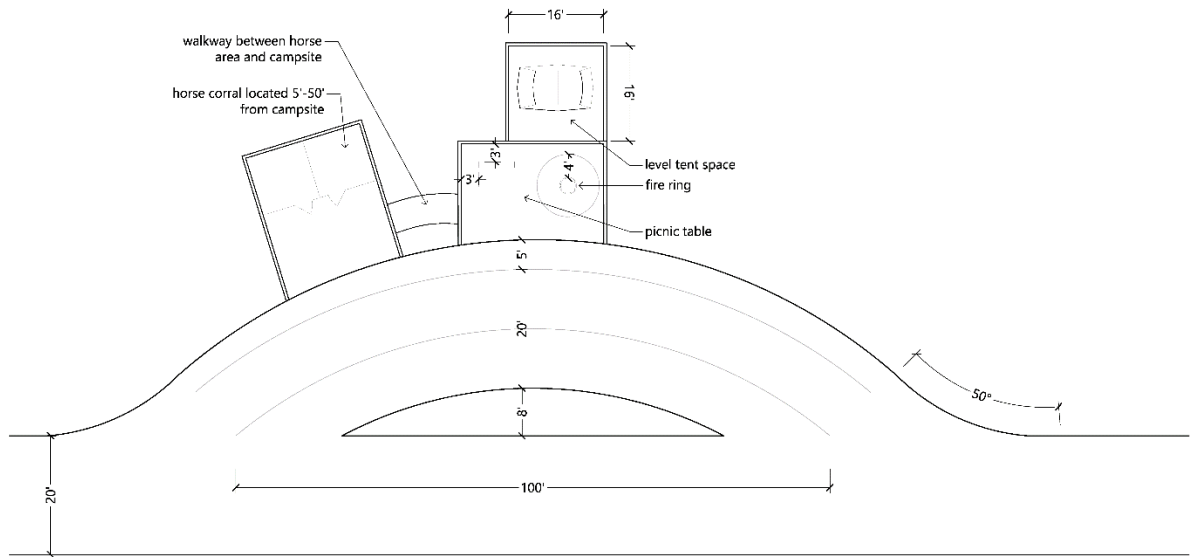

Figure 3.52 Accessible pull through equestrian campsite with tent pad, picnic table, fire ring, walkway to horse corral, and paved parking spur.



Figure 3.53 Quinn Meadow Horse Camp, US Forest Service.

Recreational Boating Campgrounds

Recreational Boating Campgrounds provide a unique overnight experience with visitors boating to a designated campground to camp overnight. Typically, these sites cannot be accessed by other means (such as by vehicle), but parks may consider allowing visitors to hike in, similar to backcountry sites. Amenities at recreational boating campgrounds can vary, but typically include a [tent area](#), [fire ring](#), [picnic table](#), and a shared [pit or vault toilet](#). As a best practice, consider making recreational boating campgrounds a “pack-in pack-out” camping experience to eliminate the need for trash removal. Accessibility considerations for recreational boating facilities can be found in [ABAAS 1003](#). For more information on water access planning reference the [River Access Planning Guide](#).

If a park includes recreational boating campgrounds, it is important to provide docks or boat tie ups at each campsite, and incorporate accessibility features. Without docks or boat tie ups, the continuous beaching of boats will erode the shoreline and degrade resources. Consider the following options for docks depending on the parks water environment ([British Columbia Park Design](#)):

- Where water freezes, use a portable dock so it can be removed seasonally.
- Where there is enough water depth and where water fluctuates, use a floating dock.
- Where water is very deep and there is a rough/rocky shoreline, use a permanent boat dock.
- The park may also consider providing a kayak dock or water ski dock depending on user groups.



Figure 3.54 An accessible kayak/canoe launch provides a wheelchair transfer bench, rails to assist getting in and out of the watercraft, and water level adjustment. (Loon Lake at Sleeping Bear Dunes National Lakeshore).



Figure 3.55 The dock at Loon Lake in Sleeping Bear Dunes National Lakeshore provides access for fishing, recreational boating, and kayak/canoe launch, while meeting universal design principles.

Maintenance consideration. The more services provided, the higher the maintenance load. Consider how often park staff can boat out to the campground to maintain these facilities. Determine if there is a benefit or option to add a maintenance road that would reduce time needed to service the sites.



Figure 3.56 Boat in campground at North Cascades National Park.

Raised Platform Sites

Depending on site conditions, a raised platform campsite may be a great option to lift tents off the ground. See ABAAS F244 and Chapter 1013 for accessibility of tent pads and platforms. The raised platform is typically made of wood with an access ramp from the parking area. Tents do not need to be provided for raised platform sites; however, canvas tents that attach to the structure are commonly used for glamping sites. These canvas tents on a raised platform are perfect for accommodating visitors that may not own all of the supplies to camp or want a slightly less primitive experience. Check with your US Public Health representative if there are any concerns about pests (mice, bats, etc.) entering the tent and creating a health hazard for visitors.



Figure 3.57 Everglades National Park, Florida, Ecotents on a platform, operated by the concession Flamingo Adventures.



Figure 3.58 Everglades National Park, Florida, Ecotents on a platform, operated by the concession Flamingo Adventures.

Group Campsites

Group campsites are popular in National Park Service sites. Although typical group sizes can accommodate 50 to 75 people, trends are changing, and there is increased demand for extended families or small group camping experiences. Having a variety of group campsite sizes, if determined by the **Market Analysis and Understanding the Visitor**, will provide for a wider variety of group preferences. Group campsites can be designed in a way that allows for smaller group areas to be reserved separate from one large reservation. For instance, group campsites can have several smaller tent clusters of approximately three tent pads and a large picnic table in a separate node. This design approach provides adaptive management so that visitors have more flexibility.

Typically, each group campsite should have their own **vault toilet**, or **comfort station**, enough tent space for the group size (which could be multiple **tent pads** or level clear ground space), enough **picnic tables** and possibly a pavilion to accommodate group sizes, group-sized **fire rings or grills**, and **parking stalls** for a mixture of cars and RVs. To reduce visitor conflicts, it is also important to locate group sites away from the main campground or create a barrier between the two with vegetation or topography changes.

At least one, and preferably all, group campsites in a campground should have accessible features. This includes appropriate furnishings (picnic tables, tent pads, fire rings, grills, comfort stations) with clear floor space and firm and stable pathways between elements.

Allow for two to three acres for each 50-user group site.



Figure 3.59 Group campsite at Wind Cave National Park.

Cabins, Fixed Walled Tents, Glamping, and Concession Lodging

Overnight accommodation cabins typically provide more services for visitors than a campsite but may range from very basic to luxury lodging. Typically, cabins in NPS sites are concession-run, as the reservations, operations, and cleaning of the cabins require more management than a typical campsite. Each cabin should have two **parking stalls** and accessible routes connecting parking to the

cabin, along with a picnic table and fire ring. Cabins may also have furniture or bunks with mattresses to provide sleeping space. Fixed wall tents may be provided on raised platform campsites as an alternative to requiring the visitor to bring a tent.

Cabin Location Recommendations:

- Cabins will be sited to take advantage of natural site landscape or topography and feel somewhat separated but with views to the amenity and a common open space to also be compatible with group use.
- Cabins will consider the ease of installing and removing personal property from a vehicle to the cabin and the proximity to the comfort station.
- Cabin siting will respond to solar orientation to the greatest extent possible on each site to capture passive solar energy and support PV systems for hot water.
- Determine the separation between cabins by the density of vegetation that can be retained between the cabins. The minimum separation of cabins should generally be 100 feet unless site conditions allow privacy with closer spacing. On open sites, separation should be increased, and natural plantings introduced to give cabins a sense of privacy.
- Site and design cabins to be accessible wherever site conditions allow accessible access to the cabin. Depending on site features, there should be an accessible cabin for each experience that is offered. Reference ABAAS scoping requirements and guestroom requirements for more information ([ABAAS F224](#) and [ABAAS 806](#)). Ensure accessibility to all common use areas of accessible cabins (including interior and exterior).



Figure 3.60 Public use cabin in Kenai Fjords National Park, Alaska, at Aialik Bay.



Figure 3.61 Public use cabin in Kenai Fjords National Park, Alaska, at Aialik Bay (backside ramp).

Backcountry Sites and Dispersed Camping

Backcountry campsites can also be found throughout many National Park Service sites, however, they typically do not provide many amenities, if any at all. This guide will not provide any specifications on backcountry sites, as it is the park's discretion to decide what **services** are provided in their backcountry sites.



Figure 3.62 Rocky Mountain National Park, Colorado, backcountry accessible campsite located roughly .5 miles from the parking area.

Special Use Sites

Individual campsites are often set aside for special uses depending on park need. Some sites may be reserved for tribal use or temporary occupation by search and rescue teams or fire crews. Some campgrounds with unique wildlife issues have a cooking area where campers commune to cook to keep food smells in one area.

Specific sites may be developed for volunteer in park (VIP) or campground hosts (often volunteers). These types of sites often offer extra services such as water, power, and storage. Sometimes administrative sites offer staff the use of an administrative laundry facility that is not open to the general public. All host sites should meet requirements for accessibility under the Architectural Barriers Act of 1968.

The desirable services for a host site include the following:

- RV water hookup with an upper hose bib with a backflow preventer (continuously connected to the host trailer) and a lower hose bib with vacuum breaker for other use.
- RV sewer hookup. In campgrounds where there is no sewer, this may require a separate vault or septic system.
- Power hookup – 50 amp
- Buried propane tank (as appropriate). This is important to provide heat and cooking without having to continually refill small tanks.
 - [Reference Manual 58 Structural Fire](#)
 - [NATIONAL FIRE PROTECTION ASSOCIATION \(NFPA\)58 Liquefied Petroleum Gas Code](#)
- Large RV space with two additional parking spaces.
- Moveable picnic table.
- Fire ring.
- Bear box in areas where required (potentially oversized).
- Additional storage shed (as appropriate).



Figure 3.63 A volunteer campground host checks-in a campsite at Glacier National Park, Montana, Apgar Campground.

CAMPGROUND SERVICES

In this section, spatial considerations and carrying capacity of the campground are assessed with regard to campground services. During campground design, it is essential to assess which services are integral to the campground and if there is room for expansion of additional services in the future. This section outlines recommendations for distances between services and campsites and outlines other important facility related considerations in campground development.

Locate an accessible campsite closer but not necessarily right next to common campground services. The distances below help ensure easier universal access to services common in a campground. These distances are guidance and may vary greatly on the existing campground design and should ultimately be determined with design discretion.

From Campsite To:	Easy (maximum distance)	Moderate (maximum distance)
Comfort Station	250 ft	500 ft
Drinking Water Hydrant	100 ft	200 ft
Trash Receptacle	200 ft	300 ft
Vehicle Parking Space	25 ft	50 ft
Picnic Unit/Area to Vehicle Space	250	500
Campground Shower	250	500

Information provided by the USDA US Forest Service Region 4 Design Team

Determining Facility Capacities

The capacity for many campground services are determined by the maximum number of people using the facility at one time – persons at one time (PAOT). This is based on estimating the full capacity of the campground, including adjacent parking areas and other facilities using the campground services. The sizing of campground services such as water and wastewater systems uses peak flow data but ultimately relies on knowing the maximum usage at one time. This can be determined by historical use data (with considerations for increased capacity as appropriate), or if this information does not exist, by the ratios below (developed by the USDA US Forest Service) to estimate the maximum PAOT. Knowing the maximum PAOT can also assist with other important campground capacities that may be defined by a park.

# of PAOT	Site Type
5	Single campsite - general and walk-in
10	Double campsite – general
1.5	Single campsite – motorcycle / bicycle
Site dependent	Group campsite
3.5	Parking space (trailhead, etc.)
40	Tour bus parking space

Example: a campground with 10 walk-in sites, 30 single campsites, 5 double campsites and a trailhead with 10 parking spaces, would result in the formula $(10 \times 5) + (30 \times 5) + (5 \times 10) + (3.5 \times 10) = 285$ PAOT at this campground.

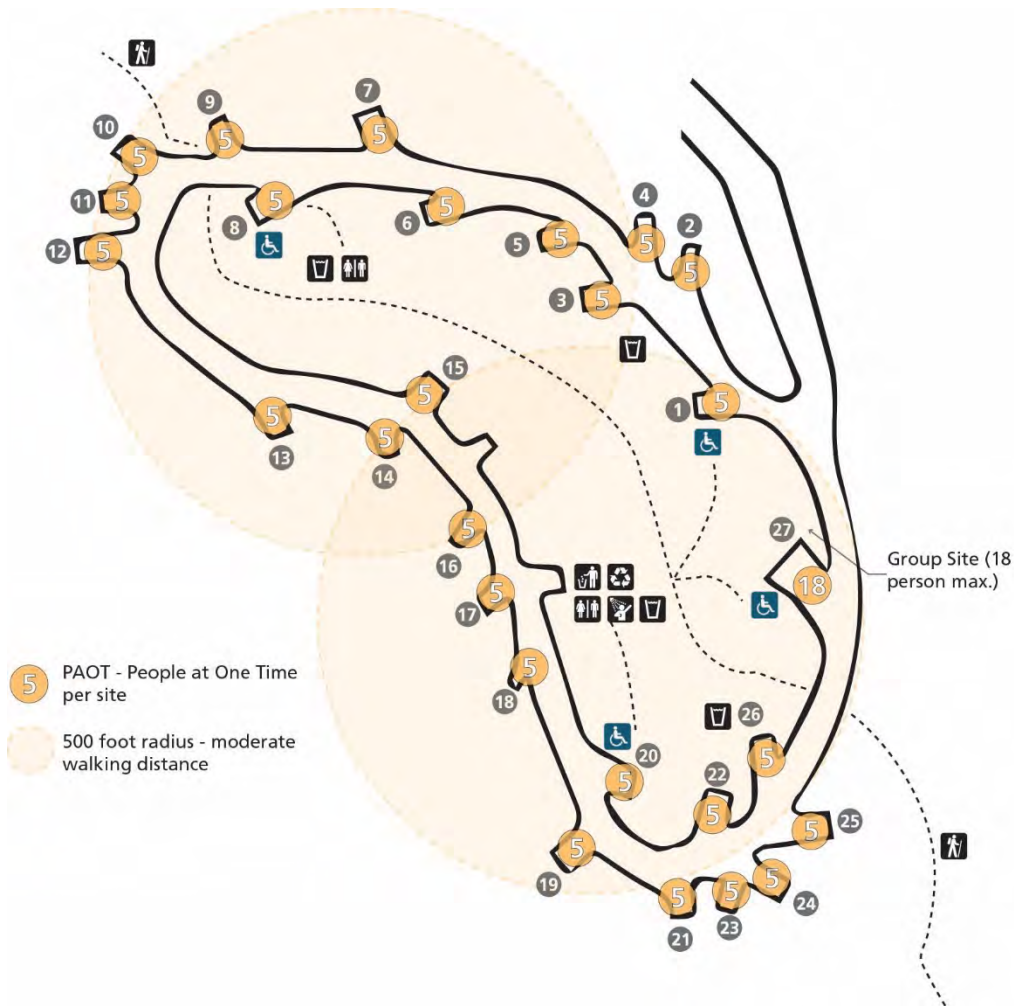

Figure 3.64 A campground with 26 campsites plus one group site of 18 PAOT equates to approximately 148 people per day ($26 \times 5 \text{ PAOT} + 18 = 148 \text{ PAOT}$). Notice the accessible sites are distributed throughout the campground and exceed the minimum number required under [ABAAS F244.2. CAMPING UNITS WITH MOBILITY FEATURES](#). 500-foot radius bubbles ensure recommended moderate walking distance to comfort stations from most of the campsites.

Estimating Water and Wastewater Capacity

Water supplies need to be designed to meet the anticipated use of the campsite. The following guidelines provide a framework for determining how much water a campsite will need, depending on which services are included.

Consumer Use	Water Gallons per day per person	Wastewater Gallons per day per person
Camping Facility	—	—
Campground without flush toilet	5–10	N/A
Campground with flush toilet	20–30	25
Campground with flush toilet and shower	25–50	35
RV Trailer water connection	25	NA
RV Trailer water and sewer connection	50	40
RV Trailer Dump Station	20–30	40
RV Trailer Host Site	50	60
Day Use	—	—
Without flush toilets	1	N/A
With flush toilets	5–10	5
With flush toilets and showers	20	20

Source: US Forest Service Handbook 7409.11, Section 44.11 – Exhibit 01 (recreation information only)

Water

Access to drinking water is important for users at developed campsites and should be considered as the most important campground service (as feasible by site constraints). In addition to drinking water, other ancillary water needs can include water for flush toilets, fire suppression needs such as fire hydrants, dish washing, and even laundering and showering at more developed campsites. The level of water service is determined by both the physical site constraints and management constraints. Size water systems according to domestic flow and fire flow (if required). Usage per person per day can be used in conjunction with the fixture unit method as well as historic flow data, if its available, to determine domestic requirements. Under sizing a water system leads to campground water shortages or low water pressure, and over sizing a system causes difficulty to maintain water quality and meet water system monitoring requirements (residual disinfection). It is also costly to overdesign a system that is not fully utilized.

Consolidating facilities that require water such as flush toilet comfort stations, showers, and water hydrants is more cost effective both in construction and maintenance. It is also easier to design a system that is consolidated to a few central areas.

In planning for a water system upgrade or replacement, fire protection alternatives need to be developed and analyzed for risk, consequences, and costs.

Where the site is located within range of a local structural fire department, structural fire protection can be provided via options, which may or may not require major capacity development of the domestic water system. If the water system is to supply fire protection, provide quantities in accordance with requirements of National Fire Protection Association (NFPA) 1131 - Standard on Water Supplies for Suburban and Rural Fire Fighting. If response time, equipment and personnel capability are suitable and if buildings with sprinkler systems are planned for the site, then a hose and hydrant system that meets NFPA 24 - Standard for Installation of Private Fire Service Mains and Their Appurtenances would be the appropriate fire protection system.

For sites located beyond the limits of a local structural fire department, the water system should only provide capacity to meet the objective of preventing fire spread to adjacent wildland or structures spaced at least 40 feet apart (see NFPA 224 - Standard for Homes and Camps in Forest Areas).

Water System Design Process

All drinking water facilities must comply with federal, state, and local regulations pertaining to drinking water sources. The following is an outline of the design process of a typical campground water system as well as where the various codes are applicable.

1. For rehabilitation of an existing water system, find as much existing information on the water system as possible. Look in park records and eTIC.
2. Verify water system classification per Environmental Protection Agency/State/NPS regulations. NPS guidance can be found in Directors Order 83 and [Reference Manual RM-83A](#). Water system classification will determine water treatment and monitoring requirements.
3. Verify capacity and quality of water source; e.g., if using an existing well, are there records of well construction to confirm that construction meets current regulations? Are there well tests to confirm the raw water quality meets current regulations? Is the well classified as groundwater or groundwater under the influence of surface water? Is the water source a surface water source? Type of water source will determine water treatment and monitoring requirements.
4. Confirm Water Rights – Does the park have the correct water rights for the volume of water needed for this water system? Contact WASO – Water Quality Division for support, if needed.
5. Determine fire flow requirements (if any) – contact the authority having jurisdiction (AHJ), provide National Fire Protection Association (NFPA) and International Organization Standardization (ISO) calculations.
 - a. Consider NFPA 1, NFPA 1142, the ISO method, and any other method deemed appropriate for the application by the authority having jurisdiction.
 - b. If water for fire flow is required, determine if it will be supplied through a combined system (potable and fire water) or if it will be supplied through a system separate from potable (dedicated fire well, draft system, etc.)
6. Determine domestic requirements:
 - a. Determine the maximum average daily demand and the peak demand.
 - b. Consider future demand – Is there any expansion planned with this project or in the next 50 years?
 - c. Consider looking at only the peak month or months for seasonal systems when determining the average daily demand.

- d. Use historic data – Collect past usage data if available—operators should have logs of pump run times and meter readings; a minimum of 5 years is ideal.
 - i. Extrapolate for future based on existing if appropriate.
 - ii. Ignore anomalies such as high-water meter readings, which are a result of line breaks or flushing lines when sizing system components.
 - iii. If historic water system data is not available, see if other visitor use data is available, such as traffic counters, trail counters, counts from a visitor center/permit office, determining the PAOT as described in section **xxxx**
 - iv. Consider turnover rates in facility usage in addition to maximum people at a site at one time
 - e. Use published tabulated data for typical usage patterns (GPD/user) to predict future demand.
7. Determine supply and storage requirements (well and supply pumps, tanks, supply piping and treatment equipment).
 - a. Size supply and treatment equipment for peak demand. National Park Service requires disinfection of every water system. Additional treatment may include iron/manganese removal, filtration, or more.
 8. Determine delivery requirements and pipe sizes (pumps, transmission lines, network lines, and service lines).
 - a. Use the fixture unit method to determine demand at each service; see [\[link to section for determining number of fixtures\]](#)
 - b. Conduct a hydraulic analysis to confirm domestic flows (and fire flows if applicable) are met at each service location

Configuration and appurtenances. The water system configuration and materials will vary widely depending on the location of the campground and the specific requirements for the system. In colder climates and in areas with campgrounds that will be open during colder months, lines, hydrants, and other water system features will need to be designed to protect against freezing. Configuration of water mains to minimize dead ends and looping of main lines as well as longer service lines is recommended to prevent dead-ends, which are a sanitary concern, and increase the potential for freezing.

Meters. Water systems for campgrounds should be metered. Meter the water at the source, if applicable, as well as at individual comfort stations or buildings with running water. Water meters are required for the operation and maintenance of a system.

Water Hydrants

Water hydrants, including water faucets on posts and handpump hydrants, are the outdoor devices from which people use to obtain drinking water.

Type of hydrants include frost proof, non-frost proof or a handpump system.

- Frostproof hydrants are generally a manufactured product. These often require preventative maintenance to ensure moving parts and seals are working properly.
- Non-frostproof hydrants are typically built by a contractor on-site. They are often made from Galvanized Steel Pipe, plumbing fittings, and a redwood 4x4 post. In areas where there are freezing temperatures, these hydrants must be drained to prevent pipe bursts.

- Handpump systems are often used in less developed campsites. These systems are frequently the only method to obtain water from a below groundwater well. Handpump systems have specially design mechanisms to pull water up. The fixtures require upkeep and testing to ensure the water remains safe for users. [The USDA U.S Forest Service has additional accessible hand pump information. https://www.fs.fed.us/t-d/programs/eng/handpump.htm](https://www.fs.fed.us/t-d/programs/eng/handpump.htm)

Ratios and distances. In a loop campsite design, ensure there is a minimum of one water hydrant per loop or an approximate distance of 100 to 200 feet from the farthest campsite. There are not any requirements for the number of water hydrants per PAOT. It is recommended that water hydrants be placed adjacent to comfort stations.

Place water hydrants in a central location that can accommodate a large number of campsites, picnic sites, and/or trailheads. When only one hydrant serves the entire campground, site it near the campground entrance or near a comfort station so that it can be easily identified by campground users.



Figure 3.65 Grand Teton National Park, Wyoming, Signal Mountain Campground, accessible frostproof water hydrant that can be operated with a closed fist.



Figure 3.66 Accessible handpump system. Photo courtesy of USDA US Forest Service.

Specifications. Hydrants should always contain a backflow preventer and be spring loaded so they automatically shut off when not in use. They should contain a smooth nose which eliminates hoses from being attached and thereby reduces cross contamination. Drainage away from the hydrant is important to prevent puddles below the water source, such as a sloping concrete pad so water flows away to native vegetation.

In instances where both a drinking fountain and a water hydrant are provided at the same site, both features should share the same splash basin and underground supply lines, if feasible.

In climates with freezing temperatures, the plumbing system must be designed so that it can be fully winterized. Depending on location, winterization can consist of heating the plumbing or completely draining the system. The latter method is most common but requires draining the water out of fixtures, water heaters, and service lines.

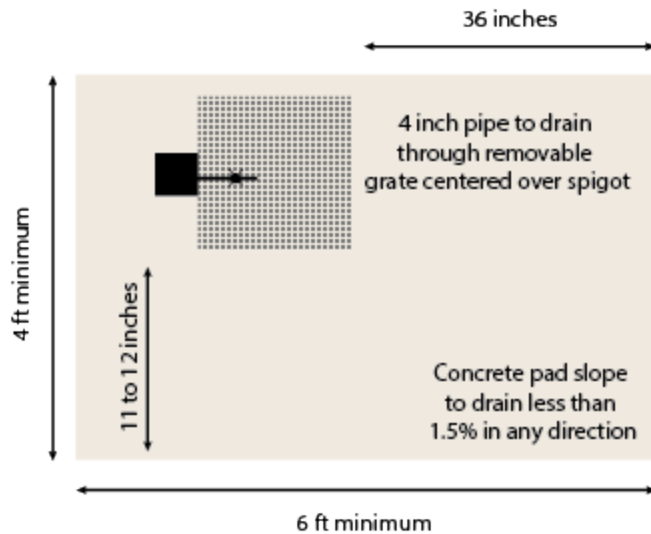

Figure 3.67 Accessible water spigot in plan view.

Sustainability. Label all drinking water sources as either “drinking water” or “clean water.” Water hydrants are different throughout the National Park Service and even within individual parks. Visitors are reluctant to fill water containers in campgrounds, picnic areas, or anywhere else if they are unsure if the water is safe to drink. As feasible, provide two types of hydrants. One that is good for filling a large container and one that is easy to use to fill a small water bottle with less pressure.



Figure 3.68 Clean water sign.

Accessibility. For water hydrants to be accessible, they need to incorporate appropriate height and reach, clearing around water source, and mechanisms designed for a variety of user abilities. It is recommended that every water hydrant has an accessible paddle handle to ensure all hydrants are accessible. Distances between water hydrants and accessible sites should be minimized, and routes should be accessible. An accessible surface of concrete, asphalt, or firm and stable aggregate is required around the water hydrant.

The following ABAAS sections apply (with links):

- Locate the faucet or operable portion of the hydrant between 28 inches and 36 inches above the ground surface ([ABAAS 1011.6](#)).

- The faucet or operable portion of the hydrant must be within a 15-inch to 48-inch reach range. The clear space centered around the water hydrant should be 48 inches by 72 inches, with the long side of the area overlapping another clear space. This clear space should be firm and stable, with a slope no more than 2.08 percent for concrete, asphalt, or boards, and no more than 3.33 percent for alternative surfaces in any direction throughout the surface if needed for drainage. This clear space permits a forward or parallel approach to the water spout and allows enough room for someone in a wheelchair to turn around and leave ([ABAAS 1011.2.1](#)).
- Typical water handpumps can be challenging to use due to their piston-like pump mechanism, which requires a long reach. In addition, deeper wells require greater force to draw water. Accessible handpumps can be purchased to accommodate wells as deep as 40 feet and should comply with accessibility requirements for grasping, turning and pressure ([ABAAS F205](#) and [ABAAS 309](#)).
- ABAAS 1011, Outdoor Constructed Features

RV Water

RV water hookups are provided as a standard garden hose bib attachment located on the driver's side. Locate the hookup 15 feet from the back of the campsite parking spur. When water and sewer hookups are located at the same spur, separate the two hookups by 10 feet or according to the state Department of Environmental Quality (DEQ).

Locate the water connection six feet away from the campsite parking spur edge and be protected with a wood or metal pole to avoid accidental vehicle damage. The hookup requires a backflow preventer. Accessible spaces require a minimum of three feet of clear space beside and in front of the water connection. [ABAAS 1011.6](#).



Figure 3.69 Hot Springs National Park, Arkansas, Gulpha Gorge Campground RV water hookup.

WASTEWATER

Wastewater systems vary greatly depending on the development of the campground. In less developed campgrounds a simple vault toilet may serve as the wastewater collection, however, in large campgrounds, complex wastewater systems may be integrated with park systems to serve a campground. There are three approaches to updating or designing a wastewater system in a campground; these include:

1. A system integrated into the current park system to accommodate new amenities/usage,
2. Construction of a new system, or
3. Some combination of integration and new, such as adding leach fields to some facilities, while others are connected to a larger wastewater system.

Wastewater systems and construction suitability are directly affected by the characteristics of the soils and slopes of a site. When assessing a site for integration of sewer, look at the topography to determine drainage and slope areas as well as the presence of surface water, location of ground water, watersheds that would be affected, and downstream potable water sources.

Wastewater System Design Process

All wastewater facilities must comply with Federal, State, and local regulations pertaining to wastewater. The following is an outline of the design process of a typical campground wastewater system.

1. Determine Design Flow
 - a. Wastewater design flows can be determined using the average daily demand for potable water, subtracting the fraction used for buildings not served by the sewer system and irrigation. If the wastewater collection system has not been rehabilitated recently, account for infiltration and inflow.
 - b. Review regulations from applicable state and local authorities for the wastewater system. Some regulations required a multiplier is applied to the average daily demand.
2. Design Collection System
 - a. Two percent minimum slope of gravity sewer pipes is recommended.
 - b. Pipes should not be less than 4-inches in diameter.
 - c. Install cleanouts, preferably double cleanouts, outside each building.
 - d. Distance between manholes should not exceed 400 feet.
3. Wastewater Treatment
 - a. There are many options for wastewater treatment. The best solution is to tie into a municipal system if possible. On-site treatment systems include septic tank and drain field, wastewater lagoons, spray irrigation, and wastewater treatment plants. Soils, topography, and maintenance capacity need to be considered when determining the best treatment solution for a site.

Ratios and distances. In determining the quality of wastewater to be treated or disposed, consider the number of sites, the PAOT, the number and type of fixtures to be installed, and whether there are plans to expand the campground area in the future.

Wastewater systems need to be sized according to the **water usage type per person per day**. Under sizing a wastewater system leads to campground contamination issues and over sizing a system can cause unnecessary burdens on maintenance staff; however, consider the need to expand soon and what that expansion may entail.

Considerations. It is important to select a wastewater system that is simple and dependable, minimizes the need for special skills to operate, is reasonable in cost to construct and maintain, and is environmentally safe. It is also integral to select a wastewater system that meets the site requirement and complies with rules and regulations of federal, state, and local agencies.

For campsites with RV dump stations, locate dump stations near the recreation facilities and such that there is no chance of infiltration of flood waters into the storage tank or seepage out of the storage tank.

Materials. Make new or replacement water lines and pressurized sewer lines out of high-density polyethylene. Make most gravity flow sewer lines out of polyvinyl chloride; however, there are applications where other materials may be suitable. Considerations in determining pipe material include pressure, bury depth, and external loading, existing pipe to connect to, installation method, etc.

Codes and resources:

- [Public Health: Protection and Prevention. Reference Manual 83A](#) for wastewater treatment systems.

RV Wastewater

When water hookups and sewer hookups are located at the same spur, separate the two hookups by at least 10 feet or according to the state Department of Environmental Quality. In addition, locate the sewer connection 4 feet from the end of the parking spur.

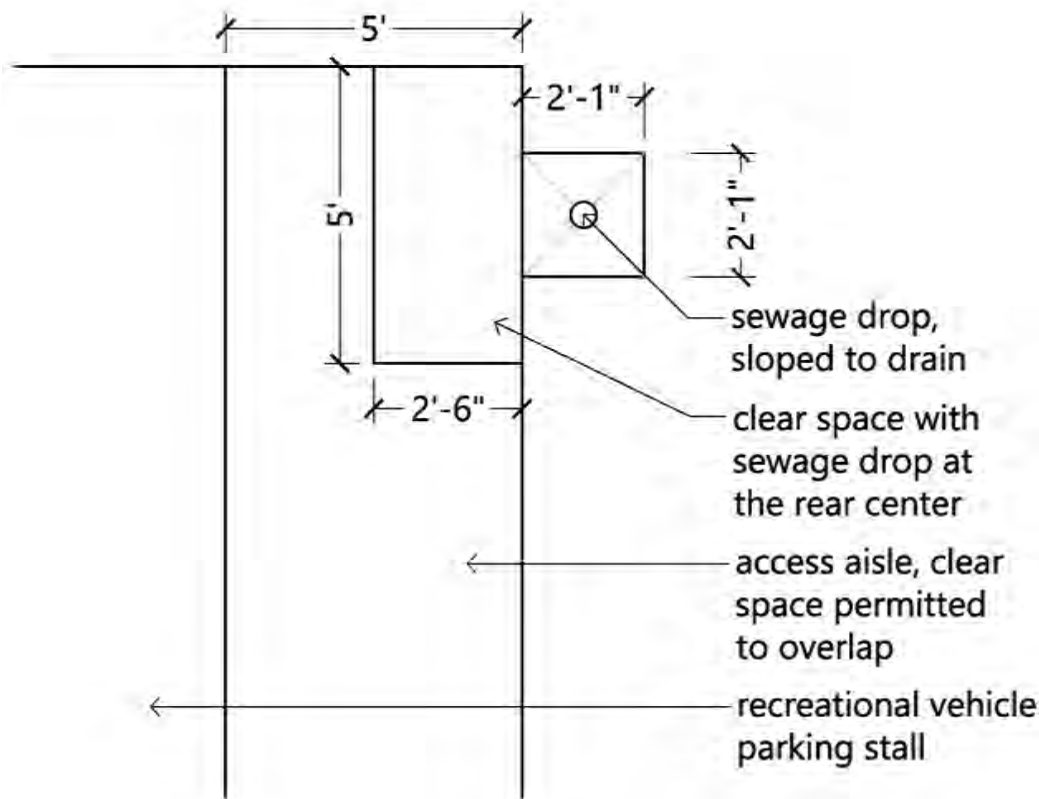

Figure 3.70 Accessible approach to sewer hookup.

Operations and Maintenance Considerations – Wastewater:

- Parks can recommend that RVs do not use products with formaldehyde for their wastewater tanks, as these disrupt the digestion in septic and wastewater systems. This recommendation can be encouraged by requiring that campground stores operated by concessions only sell bio-degradable treatment.
- RV wastewater systems are sometimes impacted because visitors place rocks around the sewer hose to hold it down. Inform visitors at check-in and with signs as needed.

Accessibility. A sewer connection at a RV Trailer accessible site shall have a minimum 30-inch by 60-inch accessible clear space adjacent to, and centered on, the grade level outlet. Locate the sewer connection 4 feet from the end of the parking spur. The long side of the clear space must adjoin or overlap an accessible parking space or pull-up space for recreational vehicles. Bollards or other barriers shall not obstruct the clear space required in front of the hookups ([ABAAS 1011.2.1](#)).

COMFORT STATIONS

Comfort stations are one of the most important components of campgrounds, as they are among the National Park Service’s most used and most frequently renovated structures. Availability of a clean restroom ranks among the highest priorities for visitors. See [Design Considerations](#) for more detailed information on the conceptual considerations. Comfort stations are often defined by the number of toilet fixtures or water closets. For example, maintenance staff will refer to an entire comfort station as an 8-fixture comfort station – meaning there are eight toilets total (including urinals) in the comfort station. This count does not include sinks.

Number of toilet fixtures (water closets per comfort station)*	Number of persons	Distance from farthest campsite
1	35	250 to 500 feet

*Campground fixtures/water closets ratio are developed to accommodate large bursts of use. For example, many comfort stations are used during the morning waking hours and the evening bedtime hours. For this reason, the ratio of fixtures per person may vary from other building codes.

There are two main types of comfort stations at campgrounds:

- Flush toilets – Flush toilets can handle large numbers of visitors and do not emit odors but are generally more expensive because they require more infrastructure that has to be maintained such as drinking water and septic or sewer systems.
- Vault toilets – Vault toilets do not require water, must be designed to handle the expected number of visitors, require periodic pumping, but are generally less expensive to construct.

Pit toilets and composting toilets are not considered for more developed campsites. Like vault toilets, pit toilets do not require water and require less infrastructure than vault toilets; they are primitive outhouses that are usually simple holes in the ground covered by a toilet riser. Pit toilets should be reserved for primitive or backcountry use and are not included in the design of a developed campground. In addition, composting toilets are not recommended for campground design, as they require more maintenance and are less effective in cold or wet climates.

In determining the type of toilet facility to install, consider construction, delivery access requirements, custodial operations, maintenance costs, availability of drinking water, and sewer connections. Also consider proximity to utilities, soil conditions and other environmental factors, the presences of nearby services such as a picnic area, trailhead, or other facility and accessibility. Another important consideration is to understand that more developed areas often generate visitor expectations that more developed comfort stations will be provided.

Ratios and Distances

In a loop campsite design, there should be a minimum of one comfort station per loop or a recommended 250 to 500 feet distance from the farthest accessible campsite. An inclusive campground aims to provide all campsites to within roughly this distance, realizing that this is not always achievable. The number of comfort stations and their distances should be evaluated to a reasonable amount within a short walking distance. The number of fixtures (unisex) should be located to serve approximately seven sites. This is based on an average of five persons occupying each campsite. The use of unisex facilities has increased over time and is often preferred by visitors with disabilities.

In campgrounds with separate male and female comfort stations, the same ratio applies. Urinals may be substituted for up to one third of the fixtures (water closets) for males but only if there are multiple fixtures required.

Separated unisex comfort stations are encouraged in many situations. Unisex comfort stations provide more flexibility for campers and maintenance professionals. For example, unisex comfort stations provide flexibility for family groups, allow family members to better assist users with varying abilities, are gender neutral, and provide separation from other campers.

An inclusive comfort station would consider the user group. In areas where a visitor preference is to squat, consider implementing squat toilets. Because of their uncommon use in the United States, these fixtures should be considered as an addition to the total number of toilet fixtures added to a comfort station and not part of the total.



Figure 3.71 Squat toilet adjacent to a standard toilet riser allows users with different preferences to have options. Photo provided by CXT.



Figure 3.72 The exterior is clearly marked indicating two types of toilets are available within the individual space. Photo provided by CXT.

Finally, ensure the siting of each comfort station complies with state and local requirements regarding setback of on-site wastewater systems from open water, drinking water, and handpump water wells. Ensure the location of the comfort station is outside of the 100-year regulatory floodplain and outside of delineated wetlands. Siting facilities within [wild and scenic river](#) corridors (with setbacks) may have specific requirements. Such facilities (especially if water-dependent or water-related, such as boat accessed campsites) are usually permitted with proper best management practices (BMPs) and mitigation measures in place.

Materials

Ensure comfort station building materials are durable enough to weather the natural elements, including fire and snow loads, and will withstand time. Building materials should reflect what is readily available in the region, considering both cost and aesthetics and design relationship to other park/campground structures (overall character), including siting, rooflines (pitch), and other considerations.

Ensure that light fixtures are both energy-efficient, are night sky-friendly, and have a timer with the potential to turn off during the late night. A gabled roof with clearstory windows allows natural light to illuminate interior spaces. Do not use shiny materials on window frames, light fixtures, or roof coverings. Use noncombustible roof coverings for new comfort stations.



Figure 3.73 This custom built vault toilet at Rocky Mountain National Park uses durable materials and aligns with the park's character. Siting vault toilets so that the stacks are high and south or west facing is critical for sweet smelling toilets.

Accessibility

All comfort stations must comply with federal accessibility standards. These requirements determine architectural elements, such as door width and placement, stall size, and height of fixtures. They also affect siting requirements related to slope, distance, and the surface material of parking lots and sidewalks accessing the restroom. If existing comfort station buildings cannot be made accessible, then a second accessible comfort station could be constructed adjacent to the original comfort station to provide an accessible option, or signage directing visitors to the nearest accessible facility can be installed until the building can be replaced. Ensure the following amenities are within reach: toilet, toilet paper dispenser, faucet, soap dispenser, hand dryer, and waste receptacle. In addition, make floors to comfort stations flush (vertically) with the material outside of the comfort station to facilitate smoother ease on wheelchairs.

Comfort stations can be the most complicated facilities for accessibility because there are many codes associated with restrooms and restroom fixtures, including the following:

- **ICC ANSI 603.2.1 Turning Space (clearances).** A turning space is provided within the room, 5'-7" (67") diameter minimum for new facilities or 5' (60") for existing facilities. The required turning space is not provided within a toilet compartment. See Accessible Routes checklist for more detailed standards.
- Concession run campgrounds operate under the Concessions Periodic Evaluation Program, which includes standards that must be met for campgrounds including comfort stations. See: https://www.nps.gov/subjects/concessions/upload/Campground_Standards.pdf

- [ABAAS 603.2.2 Door Swing \(clearances\)](#). Doors do not swing into the clear floor space or clearance required for any fixture. Doors are permitted to swing into the required turning space. EXCEPTION: Where the toilet room is for individual use and an accessible clear floor space is provided within the room beyond the arc of the door swing, doors are permitted to swing into the clear floor space or clearance required for any fixture.
- [ABAAS 603.3 Mirrors](#). Mirrors located above lavatories are installed with the bottom edge of the reflecting surfaces 3'-4" (40") maximum above the finished floor. Mirrors not located above countertops with lavatories are installed with the bottom edge of the reflecting surfaces 3'-4" (40") maximum above the finished floor. EXCEPTION: Other than within accessible dwelling or sleeping units, mirrors are not required over lavatories or counters if a mirror is located within the same toilet or bathing room and mounted with the bottom edge of the reflecting surfaces 2'-11" (35") maximum above the finished floor.
- [ABAAS 603.4 Coat Hooks and Shelves and 604.8.3 Coat Hooks and Shelves](#). Coat hooks are located between 1'-3" and 4' (15" and 48") above the finished floor. Shelves are located between 3'-4" and 4' (40" and 48") above the finished floor.
- [ABAAS 603.5 Diaper Changing Tables](#). Diaper changing tables are accessible to a user in a wheelchair. The top of the changing station is between 2'-4" and 2'-10" (28" and 34") above the floor, with 2'-3" (27") minimum knee clearance space under the surface. Clear floor space is provided at changing station, 2'-4" by 4'-4" (30" by 52") for new facilities or 2'-6" by 4' (30" by 48") for existing facilities from a forward approach with a 2% maximum slope in any direction on a stable, firm, and slip resistant surface.
- ICC ANSI 603.6 **Operable Parts**. Operable parts on towel dispensers and hand dryers serving accessible lavatories are operable with one hand and do not require tight grasping, pinching, or twisting of the wrist. The force required to activate operable parts is 5 pounds maximum. Reach ranges comply with Table 603.6.
- ICC ANSI 606.2 **Clear Floor Space**. A clear floor space is provided at lavatories and sinks, 2'-6" by 4' (30" by 48") minimum for existing facilities or 2'-6" by 4'-4" (30" by 52") minimum for new facilities from a forward approach, with 2'-3" (27") minimum knee clearance and 9" toe clearance. EXCEPTION: No more than one bowl of a multi-bowl sink is required to provide accessible knee and toe clearance.
- [ABAAS 606.3 Height](#). Lavatories and sinks have rims 2'-10" (34") maximum above the finished floor.
- [ABAAS 606.4 Faucets](#). Controls for faucets are operable with one hand without tight grasping, pinching, or twisting of the wrist, and operable with no more than 5 pounds of force. Hand-operated metering faucets remain open for 10 seconds minimum. EXCEPTION: Automatic faucets are not required to comply with section 309 provided that the reach depth to activate the faucets and the reach depth to the water flow is 11" maximum.
- ICC ANSI 606.5 **Lavatories with enhanced reach range**. Where enhanced reach range is required at lavatories, faucets and soap dispenser controls have a reach depth of 11" maximum. Water and soap outlets are provided with a reach depth of 11" maximum. The lavatory is 2'-10" (34") maximum above the finished floor, measured to the higher of the rim or counter surface. EXCEPTIONS: Enhanced reach range faucets and soap dispensers are not required on lavatories provided with automatic faucets and dispensers where the reach depth to activate them is 11" maximum.
- [ABAAS 606.6 Exposed Pipes and Surfaces](#). Water supply and drainpipes under lavatories and sinks are insulated or otherwise configured to protect against contact. There are no sharp or abrasive surfaces underneath lavatories and sinks.
- [ABAAS 604.2 Location and 604.9.1 Location](#). The water closet in wheelchair compartments and ambulatory compartments has a wall or partition to the rear and to one side. The centerline of the toilet is between 1'-4" and 1'-6" (16" and 18") from the side wall or

partition, except in ambulatory toilet compartments where it is between 1'-5" and 1'-7" (17" and 19") from the side wall or partition.

- [ABAAS 604.3.1 Clearance Width and 604.3.2 Clearance Depth](#). Clearance around the water closet is 5' (60") minimum measured perpendicular from the side wall and 4'-8" (56") minimum measured perpendicular from the rear wall.
- [ABAAS 604.3.3 Clearance Overlap](#). The required clearance around the toilet is permitted to overlap the toilet, grab bars, dispensers, coat hooks, shelves, accessible routes, clear floor space, turning space, and clearances required at other fixtures. No other fixtures or obstructions are located within the required water closet clearance. See figure 604.3.
- [ABAAS 604.4 Height](#). The seat height of the toilet is between 1'-5" and 1'-7" (17" and 19") measured to the top of the seat.
- [ABAAS 604.5 Grab Bars](#). Grab bars for water closets are accessible and provided on the side wall closest to the toilet and on the rear wall.
- [ABAAS 604.5.1.1 Side Wall Horizontal Grab Bar](#). The side wall horizontal grab bar is 3'-6" (42") long minimum, located 1' (12") maximum from the rear wall and extending 4'-8" (54") minimum from the rear wall.
- ICC ANSI 604.5.1.2 Side Wall Vertical Grab Bar. The side wall vertical grab bar is 1'-6" (18") long minimum, with the bottom of the bar located between 3'-3" and 3'-5" (39" and 41") above the floor, and with the center line of the bar located between 3'-3" and 3'-5" (39" and 41") from the rear wall.
- [ABAAS 604.5.2 Rear Wall](#). The rear wall grab bar is 3' (36") long minimum, located 6" maximum from the side wall, and extends 3'-6" (42") minimum from the side wall. EXCEPTION: The rear grab bar is permitted to be 2' (24") long minimum, centered on the toilet, where wall space does not permit a length of 3' (36") minimum due to the location of a recessed fixture adjacent to the toilet.
- [ABAAS 604.6 Flush Controls](#). Flush controls are hand-operated or automatic and located between 1'-3" and 4' (15" and 48") above the floor. They are located on the open side of the water closet except in ambulatory accessible compartments where they can be located on either side of the water closet.
- [ABAAS 604.7 Dispensers](#). Toilet paper dispensers are operable with one hand. Where the dispenser is located above the grab bar, the outlet of the dispenser shall be located between 2' and 3' (24" and 36") from the rear wall. Where the dispenser is located below the grab bar, the outlet of the dispenser is between 1'-6" and 4' (18" and 48") above the floor. EXCEPTION: Toilet paper dispensers that accommodate a maximum of two toilet paper rolls of not more than 5-inch diameter each are permitted to be located between 7" and 9" in front of the of the water closet measured to the centerline of the dispenser. Toilet paper dispenser must not interfere with use of the grab bar.

Operations and Maintenance Considerations – FLUSH TOILETS:

- Flush toilets should include a separate room to store cleaning supplies and other materials.
- Interiors made of concrete are preferred as they are easier to wash out and clean.
- Ensure proper placement of soap dispensers and other site amenities as these are common accessibility ([ABAAS 606](#)) mistakes.
- Consider sinks with built-in dryers and soap
- Low flow toilets can sometimes cause issues with a wastewater system because there is not enough water to wash the effluent to the plant. Consult with USPHS or utility operator before making any large changes to water flow.

Sustainability

Design comfort stations with sustainability in mind and incorporate any and all feasible measures to reduce the footprint to the natural environment. The orientation of the windows can help reduce the need for electricity. If the comfort station has lighting, solar panels can be used, and ensure they are properly oriented for maximum solar gain. To conserve water, consider integrating the following into the comfort station design: low-flush toilets, low-pressure sinks, and water-saving showerheads.

Flush Toilets

Where feasible, flush toilets are preferred by visitors. Common considerations must be made prior to adding these facilities (see [Pre-Construction Considerations](#)). Flush toilets can handle a large number of visitors and are best suited for high-use and developed campgrounds. Unlike vault and pit toilets, flush toilets do not emit odors. Flush toilet comfort stations are more expensive because they have the most infrastructure, require drinking water and septic or sewer systems. If existing flush toilets are in place and the wastewater system allows, consider maintaining the same existing infrastructure throughout the campground.

Interior. Flush toilet comfort stations will contain the most interior amenities of all types of comfort stations. Showers and laundry facilities are not often included; however, tools developed as part of the [business case evaluation](#) for campground modernization will assist parks in making the decision to include these features. Amenities that are typically included in flush toilet comfort stations include:

- Toilets (low-volume flush)
- Sink
- Mirror
- Electric outlet (AFCI per codes)
- Soap dispenser
- Hand dryer
- Shelf or countertop for placing personal items
- Hooks for hanging personal items
- [Lighting](#) (to supplement daylight through windows)
- Waste receptacle
- [Dish-washing sinks](#) – located on building exterior
- Hot Water (in some situations)
- Heating (in some situations)
- [Showers](#) (in some situations)

Exterior. Flush toilet comfort stations frequently include an exterior [dishwashing](#) or utility sink, a water hydrant for drinking water, and sometimes a bottle filling station.



Figure 3.74 Prefabricated toilets can be ordered in a variety of styles in effort to meet the park architectural character. To soften the appearance of newly installed vault toilet units, revegetate with native plants. (Hoh Rainforest, Olympic National Park).

Mission 66 Comfort Stations

While high-profile buildings, such as Mission 66-era visitor centers, are more clearly recognized for their contribution to the period, smaller buildings, like comfort stations, are more numerous and may also contribute to the historic character of a park. Given their function, comfort stations are not highly regarded, architecturally or culturally, and are particularly prone to renovation, presenting concerns about the gradual loss of integrity of these small, but distinctive buildings.

It is important to identify Mission 66 character-defining features and elements such as massing, materials, window position, etc. and develop design and maintenance guidelines. Developed guidelines are intended to direct and shape the efforts of planners, architects, and maintenance personnel as they work on future renovations in order to protect the comfort stations' Mission 66 character.² Mission 66 comfort stations were designed within a site context. Campgrounds with Mission 66 comfort stations should receive an evaluation of cultural landscape resources. See [Preconstruction Considerations](#) for more information.

Considerations for adapted historic comfort stations. There are many reasons to modify historic comfort stations including accessibility, usability, deferred maintenance and operations. It is important that comfort stations work for today's users.

There are three main approaches to alter historic comfort stations

1. Adapting existing comfort station
2. Expanding and adapting existing comfort station (rehabilitation)
3. Adding a new building adjacent to the existing comfort station

2. Design and Maintenance Guidelines, Mission 66 Comfort Stations, National Capital Region

To guide design changes:

- Look for common character defining features in the comfort stations.
- Identify common thread of architectural features.
- Look at the site in relationship to the building, as well as the building itself. Historic comfort stations were subservient to the landscape.
- List key areas to use to guide new design, such as:
 - siting and relationship to topography
 - topography to roof line (height and pitch)
 - materials (should be compatible in color, texture, etc.)
 -

1931 Comfort Station



CCC (1934) Comfort Stations



Mission 66 Comfort Stations



Figure 3.75 Proposed upgrades to comfort stations at Yosemite Tuolumne Campground were based on each era and the contributing features to the historic fabric of each structure. Treatment recommendations are different for each type, but all of them will be upgraded to meet accessibility requirements.

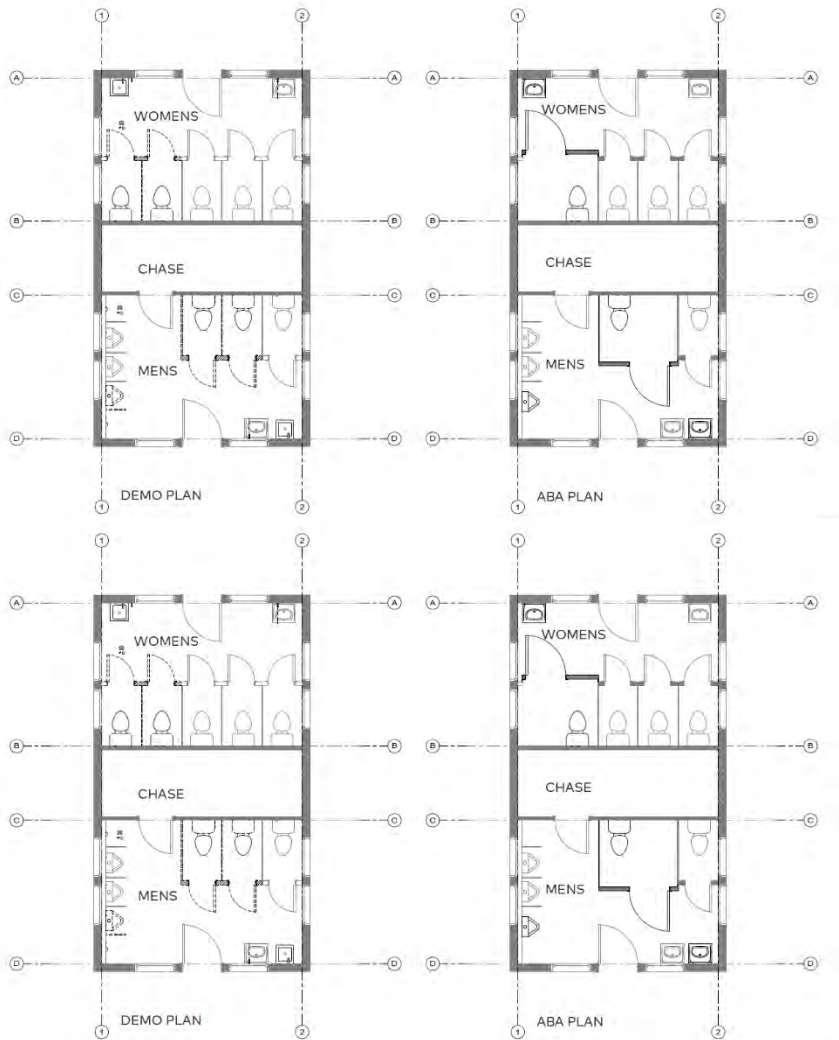

Figure 3.76 For example, to upgrade the CCC comfort station at Tuolumne Campground in Yosemite, stalls and fixtures need to be removed to meet accessibility requirements. See demolition versus proposed accessibility plans above.

Vault Toilets

A vault toilet is a waterless toilet used over a sealed underground tank. These types of toilets are frequently used where wastewater systems are either not available or not cost effective.

Site placement. Proper site placement of the vault is crucial, as improper placement will result in a malfunctioning vault toilet. Place vault toilets at least 100 feet away from water supply and five feet above the water table. These units require waste removal using a pump truck, which means that vehicular access is required—usually less than 100 feet in distance. This can pose a challenge for siting units discreetly. The vault cleanout panels, also known as outside/through service chase, are generally located on the same side of the structure as the stacks (i.e., the rear), requiring good access to the rear for pumping.



Figure 3.77 Vault toilet site placement.

Orientation of the vault should take advantage of both the wind flow and the sun’s energy to minimize the smell often associated with a vault toilet unit. Orient the unit for unobstructed solar heat gain to the vent pipe to provide the upward draw of air. Do not place the vault toilet unit in a hollow, beneath an overhang, on the lee side of a ridge, immediately adjacent to a dense tree line, or in dense brush and/or trees. It is important to avoid placing two, single-unit or two, two-unit toilet buildings close together and in line with the wind.

For detailed information on the siting refer to the US Forest Service Tech Tip, SST Installation Guide ([0323-1303P-SDTDC](#)).

Siting vault toilets can be challenging for campground design as these types of comfort stations need to be out in the open and therefore make a greater visual impact than that of historic (Rustic or Mission 66) comfort stations.

The US Forest Service Tech Tip, SST Installation Guide (0323-1303P-SDTDC), is intended to acquaint engineers, architects, and others with the basic principles of SST technology.

Ratios and distances. In a loop campsite design, ensure there is a minimum of one comfort station per loop or a recommended 250 to 500 feet distance from the farthest accessible campsite. An inclusive campground aims to provide all campsites to within roughly this distance, realizing that this is not always achievable. Evaluate the number of comfort stations and their distances to a reasonable amount within a short walking distance. Locate the number of fixtures (unisex) to serve approximately seven sites. This is based on an average of five persons occupying each campsite. The use of unisex facilities has increased over time and is often preferred by visitors with disabilities.

Separated unisex comfort stations are encouraged in many situations. Unisex comfort stations provide more flexibility for campers and maintenance professionals. For example, unisex restrooms provide flexibility for family groups, allow family members to better assist users with varying abilities, are gender neutral, and provide separation from other campers.

An inclusive comfort station would consider the user group. In areas where a visitor preference is to squat, consider implementing squat toilets. Because of their uncommon use in the United States,

these fixtures should be considered as an addition to the total number of toilet fixtures added to a comfort station and not part of the total.

Organic composting toilets are sometimes used where service access for pumping is difficult or unfeasible. However, composting is not recommended unless there is dedicated staff to operate and maintain the facilities. Locate composting toilets in only warm, dry locations where composting is likely to be successful. Most of the public composting toilets in the National Park Service have not worked as desired.

Operations and Maintenance Considerations – VAULT TOILETS:

- A concrete vault is the preferred material choice. Polyethylene vaults crack over time and need frequent replacement.
- Parks with "dynamic" environments may consider pre-cast, easy to install units. For example, a coastal park can move these units more easily if area is damaged by a storm and the visitor use area changes.
- A standard concrete vault holds up to 1,000 gallons of waste. Consider the PAOT and the average volume of waste generated to determine how frequently the vault will require pumping. Roughly 400 uses equate to about 100 gallons of waste. A vault will require pumping when it is roughly 80 percent full.
- To reduce refuse inside the vaults, place a trash can inside of the comfort station. Be mindful of trash can placement, as it may hinder [ABAAS 1011.2.1](#) compliance for clear floor space.
- In parks with bears, signs to close the door may be required, as the inside of vault toilets often attract wildlife.
- Screens can be added to the top of the vault pipe to prohibit birds (including owls) and bats from entering the pipe. More information on a potential product can be found here: https://tetonraptorcenter.org/assets/media/files/poo_poo_brochure_2019_1.pdf
- Because vault toilets are generally used in more primitive areas, a gravel surface often surrounds the vault. To maintain [ABAAS 303](#), changes in level, fill will be required on a frequent basis to maintain the vertical standard. A hardened approach (concrete, asphalt, etc.) is preferable to increase accessibility and minimize maintenance.
- As a best practice, include hand sanitizer and dispenser near the door on the inside of the unit.

[above text in text box or other text effect]



Figure 3.78 North Cascades National Park, Ross Lake Campground vault toilet cleanout. Make sure that the backside of the vault toilet is easy for a pumper truck or in this situation a pumper barge, to access. Materials. Make prefabricated vault toilet buildings out of concrete or masonry. If located in a very hot climate, insulate the roof to ensure the proper air currents and functioning of vault ventilation.



Figure 3.79 Joshua Tree National Park, Ryan Campground, vault toilet blends into the adjacent landscape.

Interior. Make all interior vault surfaces out of concrete and seal them to prevent leaking and absorption of odors into the material used to construct the vault. Completely seal the floor and upper three to four inches of the side to prevent staining and odor absorption and ensure they have a non-slip surface and are sloped two percent from the back to the front door to facilitate proper drainage and easier cleaning of the facility. Round the corners in the vault to facilitate cleaning as well. Make sure the interior walls are nonporous, light in color, and made of material that is easy to clean. Ensure walls are free from ledges, angels, and shelves to prevent dirt accumulation. Insulate the ceiling to prevent sun-heating via the roof.

Toilet specifications. The typical vault is approximately 1,000 gallons. Vault depth is recommended not to exceed five feet to ease pumping, via an exterior cleanout. Vaults may be deeper in colder climates where a greater volume of waste is created and pumping cannot occur as regularly because of freezing during the winter season.

The vault itself should have a black interior to prevent the visitor from seeing waste when looking down the toilet riser. Do not use bituminous materials for coating the vault because that material is food for bacteria. The vault should have a bottom slope of 11 inches per foot from under the toilet riser out to the outside cleanout area so that waste can be more thoroughly removed.

Make certain the toilet riser is free of cracks and crevices to prevent odorous materials from collecting. The riser should have a heavy-duty open front seat and cover assembly that does not seal the air out. Ensure the riser is easy to clean and impervious to oxidizing cleaning agents.

Ventilation. Install one vent opening in the vault building, with the opening placed on one side of the building (side, front, or back). Late the vent to be “head-high” on the building if there is a constant prevailing wind hitting that side. For shifting winds, place the vent as low to the ground as possible and on the side that the wind is most predominant during the use period. If there is an up-canyon wind in the morning and a down-canyon wind during the afternoon, then place the vent on an adjacent wall surface as low to the ground as possible so that the wind has the least effect of aspirating air out of the building.

Construct the vent of a heavy-duty material, such as expanded metal, to prevent vandalism. Make sure the vent is around 120 square inches and 12 inches in diameter for one single unit toilet.

Ensure the top of the vent pipe is at least three feet above the highest point of the roof, and paint the 12-inch diameter pipe a dark color to promote convection from the sun. The top of the vent pipe should remain unobstructed, but a screen to keep wildlife out is recommended to promote proper ventilation upwards.

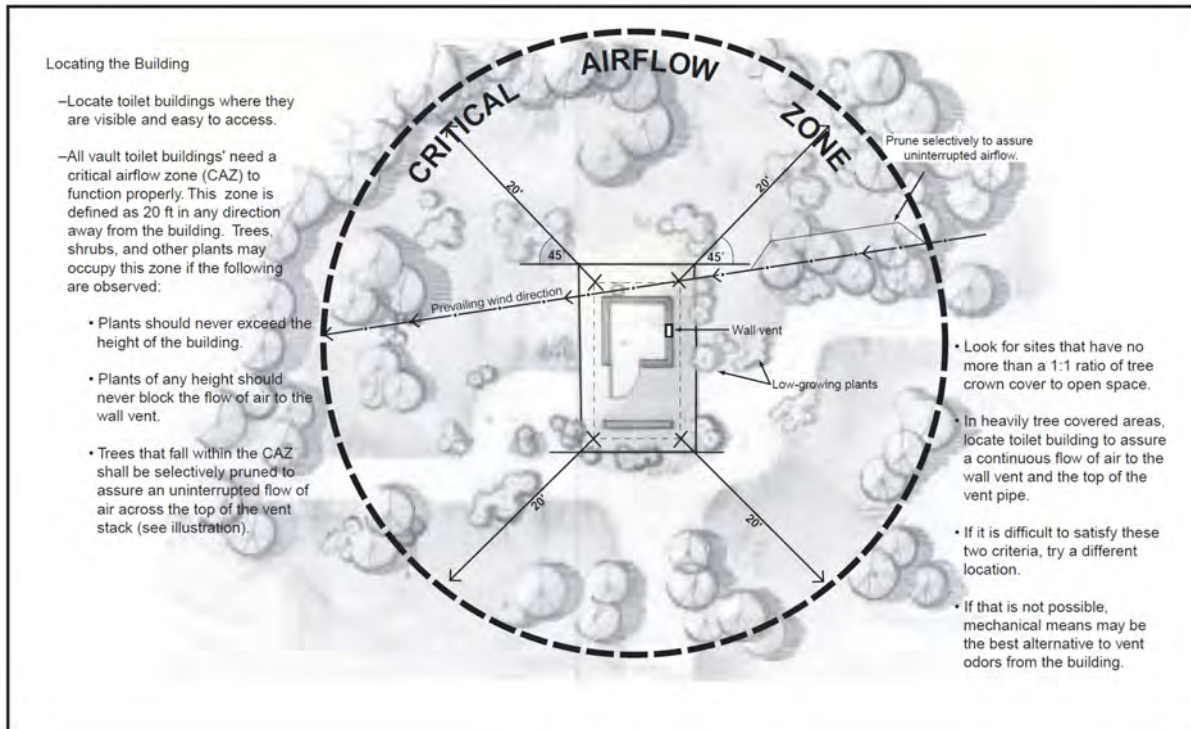

Figure 3.80 Diagram demonstrating distances for vault toilet installation. USDA Forest Service, Technology and Development Program. SST Installation Guide. 0323-1303. May 2003.

Exterior. Unique to vault toilets, the exterior should have a 24-inch diameter (minimum) lightweight cleanout cover installed to the rear or side of the building. The cleanout cover must be sealed to prevent air and water from entering the vault and secured to prevent unauthorized entry. Ensure the cleanout cover is raised, with the surrounding concrete sloped away using a minimum slope of 1/2 inch per foot. In addition, slope the exterior walkway to the vault to drain away from the building at a slope not to exceed two percent.

Accessibility.

[Link to previous document section with [ABAAS links.](#)]

Dishwashing Stations

Flush toilet comfort stations frequently include a dishwashing or utility sink. In general, if sinks with running water are included inside of the comfort station, then provide a separate dish-washing sink provided; otherwise, visitors will use the hand washing sink for dishwashing. Common considerations include a grease trap for the sink, overall sink maintenance, bear and other animal considerations (leftover food particles), and accessibility in small closed-door areas.

Ratios and distance. Provide roughly one dish washing sink per flush comfort station. Dish washing / water hydrant areas may be provided in less developed campgrounds. Be sure to provide a proper drain and signs detailing no food waste.



Figure 3.81 The outdoor dish washing sinks at Glacier Basin campground in Rocky Mountain National Park are integrated on the comfort station exteriors and provide a firm and stable surface and knee clearance for accessibility.

Accessibility.

[ABAAS 606 Lavatories and Sinks](#)

[ABAAS 804 Kitchens](#)

Electrical Services

The determination to include utility hookups depends on a variety of factors, including the demand for RV hookups at the site, campground location and size, availability of commercial campgrounds in the area, and the cost of installing and maintaining the services and utilities. [See business case decision tools section.](#) Campsites designed for RVs should provide electrical services in a covered and grounded electrical box mounted to a post or in a manufactured assembly that includes a ground fault interrupter.

In addition to RV hookups, consider charging stations for personal devices. These can be located at comfort stations, fee stations, or individual campsites. When determining total electrical load, account for electrical draws such as water pumps and building usage.



Figure 3.82 Electrical camp site panel with 30-amp and 50-amp connections. Consider locking bottom portion of panel to prevent tampering with electrical capacity.

Distance and ratio recommendations. Utility services will be mounted to a post or as part of a manufactured assembly, and the guard post will be four to five inches in diameter and filled with concrete. Pedestals will provide a minimum of one 50-amp, 3-phase outlet and one 20-amp, single phase outlet. Locate pedestals on the driver side of the parking pad approximately 15 feet from the rear of the pad, protected by a steel guard post located 18 to 24 inches away.



Figure 3.83 Many camper pop-outs are located on the same side as the utility hookups. For this reason, additional protection is needed to prevent a camper for inadvertently damaging utilities.

Design considerations. Place buried utility services under road and trail routes wherever possible to minimize disturbance of the surrounding vegetation. Ensure power is underground in all use areas, with warning tape placed in the trench above electric lines so that it can be located for future digging operations. Electrical facilities at each campsite need to be sized to comply with local building codes and National Electrical Code, Section 551. It is important to develop tamper-proof electrical power to avoid amp issues and capacity tripping when adapters are used to pull additional power. It has become a problem in some parks that offer electrical hookups; users are employing adapters to pull more power than designed for. This is a fire hazard and can have dangerous implications and cause tripped breakers. This is not a safe practice under NFPA 70 article 551.

Where electrical hookups are provided, generator use can be reduced or eliminated. Generator use can negatively impact the experience of campers that do not use generators. Locate sites allowing generator use in a separate area to eliminate impact to visitors. Increasing the availability of electricity at campsites is also encouraged for inclusivity of people with disabilities. Visitors may need to recharge powered mobility devices or require a power source for use with breathing apparatus during the night. Make sure these visitors are able to disperse throughout the campground and not always be forced into camping in highly developed areas.



Figure 3.84 Directional sign showing a generator-free loop.

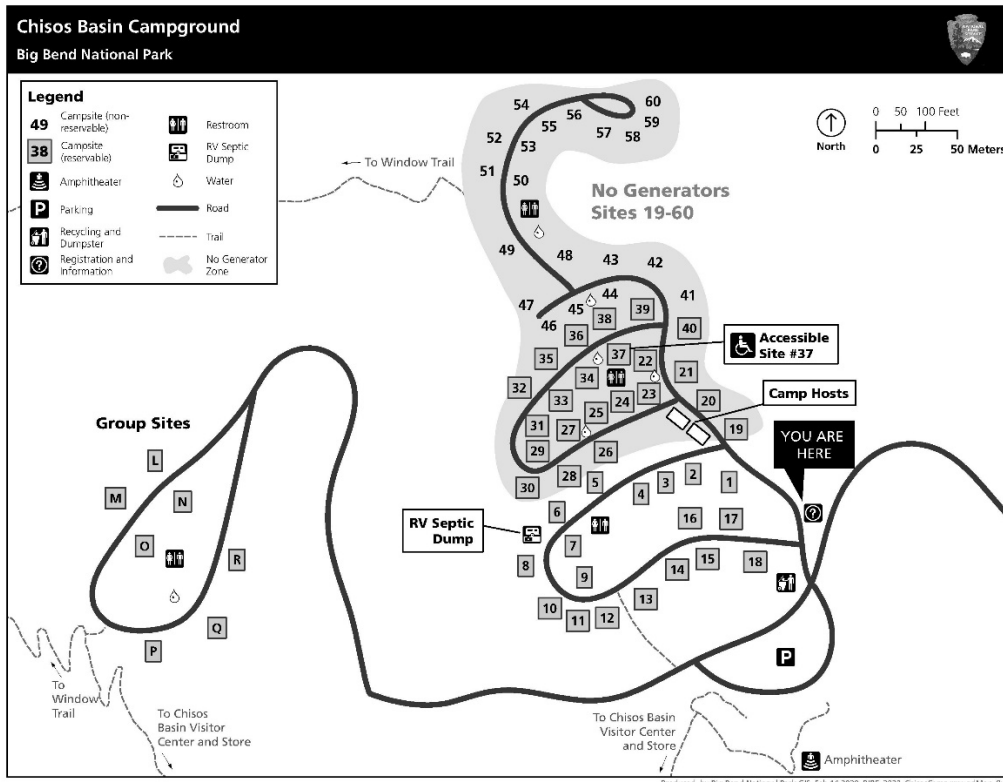

Figure 3.85 Big Bend National Park, Texas, Chisos Basin Campground, Campground Map clearly indicates generator-free area.

Accessibility. An electrical connection at a RV Trailer accessible site shall have a minimum 30-inch by 60-inch accessible clear space adjacent to, and centered on, the post. Locate the space so that the hookups are at the rear center of the space. The long side of the clear space must adjoin or overlap an accessible parking space or pull-up space for recreational vehicles. Bollards or other barriers shall not obstruct the clear space required in front of the hookups ([ABAAS 1011.2.1](#)).

LIGHTING

Lighting can be installed both indoors and outdoors to enhance the visitors' experience and improve safety at campsites. Lighting design must consider the following: local, state and federal codes, and the intentional preservation of dark night sky. Different colors of lighting (color temperature and spectrum) can be used to reduce attracting insects and provide additional night sky protection.

Indoor Lighting

Ensure the lighting within campsite facilities, such as comfort stations, is adequate for the visitor to function safely, without providing high-intensity light. For example, use natural lighting for bathroom and showers that is supplemented with either motion-activated or switch-activated artificial lighting for evening use. Interior lights can also be shielded from windows to reduce light pollution.

Outdoor Lighting

Use low intensity lighting within a campground and provide illumination only where necessary for safety. Outside of comfort stations, lighting may be used to illuminate the external sidewalks, nearby ground surfaces, and amphitheaters as needed. Consider adding an automatic shut off to turn off the light during late night hours.

Best Practices for Preserving Dark Night Skies

Dark night skies are an integral experience at campsites and must be actively preserved through intentional lighting design. All indoor and outdoor lighting should integrate the following best practices for preserving dark night skies:

1. Avoidance
 - a. Light only when required for safety of visitors and staff, to the extent practicable.
 - b. Maximize distances of lighting from sensitive areas.
 - c. Encourage visitors to minimize personal outdoor lighting.
2. Screen
 - a. Use physical barriers and existing terrain to reduce light trespass.
3. Direction and Shielding
 - a. Mount lights and direct downward.
 - b. Use partial shields and limit up-tilt.
 - c. Point lights away from sensitive areas.
4. Adjust Duty Cycle
 - a. Use motion sensor controls in infrequently used areas.
 - b. Use timers to control lighting only during night hours of typical use.
5. Brightness
 - a. Use the smallest amount of total lighting possible to still meet the lighting need.
6. Color and Spectrum
 - a. Use amber light when color rendering is not critical.
 - b. Limit light to 3500-degree Kelvin when color rendering is critical.
 - c. Avoid blue/white light spectrum when possible.



Figure 3.86 Captions in order from top to bottom:

- Photo 1 – Rustic wood frame lighting post at Yosemite National Park campsite.
- Photo 2 – Wedge bollard light to brighten walkways at Yosemite National Park.
- Photo 3 – Sky guard lighting fixture at Yellowstone National Park.
- Photo 4 – Light on A-frame structure at Yellowstone National Park.
- Photo 5 – Industrial shaded light at Yosemite National Park.
- Photo 6 - Tall light posts at Grand Canyon National Park’s Historic District.



Figure 3.87 Milky Way over Spatter Cones at Craters of the Moon National Park.

TELECOMMUNICATIONS

At a minimum consider installing internet lines to the campground entry or a central kiosk or gathering place. This would allow installation of limited Internet or Wi-Fi and allow payment by phone. Consider where else it is appropriate and/or feasible to provide wireless internet access, to facilitate visitors' trip planning, communications with other parties and access to park educational and interpretive content. Cellular phone access can be a critical accessibility tool for many types of disabilities. Additional telecommunications services to consider in campground design include cellular service, satellite and cable. The industry trends report indicates that WIFI is of low priority for campground visitors in National Parks. However, this survey focused on visitors who already camp in National Parks and did not survey non-NPS campers and their value for of WIFI in a campground. WIFI service may be provided through a third party for a fee, be an added fee through an existing concessioner, or be included in the site fee as a campground amenity.

In general, bury telecommunication lines underground and follow road and trail alignments. If possible, combine utilities in one trench. Provide accessible telephone or emergency call box service in public use areas where no service is provided, and make certain at least one telephone or call box allow for emergency calls to be made without coins. Use international symbol signs to denote phone or call box locations. Ensure call box locations are accompanied by adequate parking, lighting, and shelter from the elements. Make sure phone service through visitors' cellular device carriers is available at all entrance stations and maintenance facilities if feasible.

AMPHITHEATER

The amphitheater has a long history in NPS campgrounds. Beginning in the late 1920s the amphitheater emerged in NPS campgrounds. The design of the facility drew from the traditions of rustic architecture and naturalistic gardening. By 1932, the amphitheater had become an important and regular feature of park campgrounds where evening ranger talks could be heard (McClelland 1998, p. 251). These landscape features are somewhat unique to NPS campgrounds. They provide an opportunity to connect with visitors and support the educational branch of National Park Service. The importance and legacy of a NPS amphitheater cannot be understated and should be considered in the modern NPS campground.

Amphitheaters are an important facility in campgrounds. However, before designing a new amphitheater or renovating an existing one, consider both the programming and source of visitors. The most successful amphitheaters have strong programs that run daily/nightly and draw visitors from the campgrounds and nearby overnight stays. Additionally, consider an adaptable amphitheater such as a flat area with no benches that can be used as picnic area or provide WIFI service within the area to promote use during times without programming. If campground interpretive programming intends to draw a smaller crowd, consider designing a campfire circle as an alternative to an amphitheater. Depending on the topography of the site and interpretive programming, it may be necessary to provide pathways and exterior lighting to help orient visitors to the amphitheater. Remember to always use energy-efficient and shielded lights to preserve the **dark sky experience**.

Siting

Amphitheaters should blend into the natural landscape. Natural hollows or graded bowls are traditionally used to create an enclosed area within the landscape. The National Park Service has a history of siting these facilities in locations that blend in with the surrounding and appear as though they have always been there. Trees and other natural screens should be used to minimize sound and light disturbances as well as create a more intimate space. In areas where the amphitheater use is dwindling, consider flexible design solutions to allow for smaller talks, campfire circle talks, etc. Slopes should carefully integrate accessible routes and landings to allow for a range of participation by users of all abilities and not limit participation to flat areas only located in the back or front. This also affects those who accompany individuals with disabilities such as children or companions.

Base the size and location of an amphitheater on expected visitation. Larger amphitheaters, such as Dana Campfire Circle in Tuolumne Meadows Campground (Yosemite National Park) receive 90 percent of amphitheater visitors from overnight campground stays.



Figure 3.88 Although not located in a campground, the Bat Flight Amphitheater at Carlsbad Caverns National Park is sited in the hillside with natural stone to blend into the landscape.



Figure 3.89 Hot Springs National Park, Arkansas, Gulpha Gorge Campground Amphitheatre.

Materials and Details

Wood, stone and other natural materials help features blend into the environment. Consider maintenance of materials and overall long-term wear.

Accessibility.

Ramps, rails, and accessible seating should be included in all amphitheaters. It is important to provide a variety of seating, including seats with backs and without backs, seating with and without armrests, and companion seating. If seating is permanent, include a variety of locations throughout the space for people using wheelchairs. Amphitheater settings should be equipped to provide assistive listening for live presentations, programs, and videos. Captions should be displayed on screens. Be sure to design accessible paths and parking to the amphitheater as well.

See appropriate accessibility links below:

- [ABAAS F221 Assembly Areas](#)
- [ABAAS 802 Wheelchair Spaces, Companion Seats, and Designated Aisle Seats](#)



Figure 3.90 A “before image” of Moraine Park Amphitheater. The amphitheater was developed in the 1950s, had out-of-date technology and in-accessible seating areas. (Rocky Mountain National Park)



Figure 3.91 The “after” image of the same amphitheater updated technology and provides accessibility to 50% of seating, including 10 wheelchair spaces integrated throughout. Seating includes benches with and without backs to enhance comfort and usability for all visitors. (Rocky Mountain National Park)

SOLID WASTE AND RECYCLING MANAGEMENT

Campgrounds are operated by both the National Park Service and concessioners. When a campground is operated by a concessioner, collaboration on waste management and recycling is the key to reducing waste. Parks must also work closely with their municipal waste handler to know what recycling is accepted.

Dumpsters are more economical than individual trash cans because of capacity and ease of collection. However, garbage dumpsters require a larger area that is accessible by a garbage truck to mechanically lift and tip the dumpster. Dumpsters must also be strategically designed into the overall campground plan and placed at a reasonable distance away from campers. Garbage dumpsters should include screening via fences or walls matching the campgrounds' architectural style. If using dumpsters for both trash and recycling collection, consider a design that has an opening at the same height and configuration as the recycle bins. This will make it easier for the visitor to sort while also being accessible. Parks with recycling programs should consider a different approach as outlined by a recent [Leave No Trace study in 2019](#) (see additional detail below).

Operations and Maintenance Call out Box

Consider having propane exchange programs in the campgrounds. One-pound propane cylinder disposal is an enormous problem in the national parks. Although these cylinders can be purchased by the camper for approximately \$5, the empty container left at the park can cost \$20 or more for each one to be disposed of properly. Program management could be by park staff, campground hosts, or concessioners.

[Above in Call out box in final]

Leave No Trace Study, 2019

Convenience is key to a successful recycling program. A Leave No Trace (LNT) study in 2019 cited reasons campers found recycling to be easy in parks included: *availability of receptacles*; *easy to understand signage*; and *receptacles that were within proximity of campsites*, respectively.

To promote recycling, pair recycling and trash containers. Matched recycling and trash containers are more appealing than dumpsters and results in less contamination in the recycling. However, individual trash containers are more labor intensive for staff to maintain than dumpsters. Ensure recycle bins can be seen and are not hidden adjacent to larger dumpsters or other obstructions. As determined by the LNT study, more frequent recycling containers throughout campgrounds are recommended. In three pilot parks used in the study, wildlife resistant tri-bins (containing three 40-gallon compartments pictured below) are scattered throughout a campground for the three top commodities (usually plastic, aluminum, glass). Then, a main recycling hub is provided at the campground entrance for additional commodities (if collected). Provide information on which commodities are accepted in each location. Label dumpsters or trash bins as “garbage” or “trash,” not “landfill.” For non-English speakers, the words “garbage” or “trash” are more commonly understood.

Green Waste and Waste Reduction Considerations

- Hand out bags that have a different color and label for recyclables and trash.
- Some parks may have the ability to compost, and compost collection could be accomplished in campgrounds, with proper planning and maintenance.
- To reduce waste, make sure to label all drinking water sources as “drinking water” or “potable water.” Visitors are reluctant to fill water containers in picnic areas and campgrounds if the source is not identified as drinking water. It is also helpful to have two hydrants: one that is good for filling a large container and one at which it is easy to fill a small water bottle (less pressure).

Maintenance. During peak visitation periods, tri-bins may need to be emptied every other day. Some parks may need to consider larger bins or have multiple bins/compartments for each commodity. Consider the appropriate size and number based on visitation and staff availability.

A trailer could be used to collect additional plastic, tin, newspaper, cardboard, etc. at the main recycling hub. There will be more plastic #2 in campgrounds because of bigger water containers, which take up a lot of space in plastic recycling bins.

The design and maintenance of trash receptacles should prevent access or disturbance by wildlife. Reduce waste and operations costs by encouraging visitors to pack out their trash. For remote campsites, consider a “pack it in, pack it out” policy to reduce operational costs of trash and recycling pickup. Campers at remote sites can be directed to a central collection location.





Figure 3.92 Trash and recycling options.

Ratios and distances. Trash cans should be located by loop entrances or intersections, away from water hydrants. The number of trash cans will depend on the campground layout and the availability of pickup services at that site. Number and size of cans should range anywhere from one can per three campsites to one can per loop (up to 40 campsites). Trash cans should be located a maximum of 100 ft away from campsites. Each campground should also have a centralized dumpster containing trash cans and other waste collection (including recycling, if available). This dumpster area should be approximately 12 ft x 6 ft x 6 ft in dimension. Accessible routes should be provided to collection cans and dumpster facilities.

Accessibility. At least 20 percent of all trash receptacles must be accessible (a minimum of two where more than one is provided), with a minimum clear space of three feet by four feet for a forward approach or 36 inches by 60 inches for a parallel approach to the receptacle opening. The surface of the clear space must be firm and stable (i.e., resists deformation by indentation). If the surface is concrete, asphalt, or boards, the clear ground space slope should be no more than two percent slope in any direction. If the surface is other than concrete, asphalt, or boards, then the clear ground space slope can increase up to three percent in any direction if needed for drainage. All accessible trash receptacles must be within a 15-inch to 48-inch reach range. Accessible trash areas should be located adjacent to accessible campsites. [ADD ABAAS CODE link](#)

In bear country, trash and recycling containers must be designed to keep the bears out, minimizing contact between bears and humans. Bear-resistant receptacles require more force than is allowed for accessible operation, and currently there is no bear-resistant accessible receptacle design. Therefore, these receptacles are exempt from the accessibility standards for reach range and operable parts, but all other requirements for clear space and surface condition must be met to the maximum extent possible. When accessible bear-proof receptacles are designed and available, there will no longer be

an exemption. Dumpsters are likewise exempted from accessibility guidelines. All other accessibility requirements (such as route and slope) must be met even if the operational force requirement cannot be met.

Design considerations. When permissible and available by local jurisdiction and pickup, recycling should be included at all campgrounds. When including recycling in design, consider amenities to facilitate separation of recyclable materials from other waste. Trash cans should be washed and/or disinfected regularly.

Dog waste. Include amenities for pet waste at sites with high concentrations of pet use. If canine waste is an issue, consider providing doggie doo bags along with information on rules for dogs (e.g., dogs are not allowed on trails, in lake, etc.). Ensure dispensers are within the reach ranges specified in ABAAS, are on a compliant accessible route, and have the required clear space for both a front and side approach.

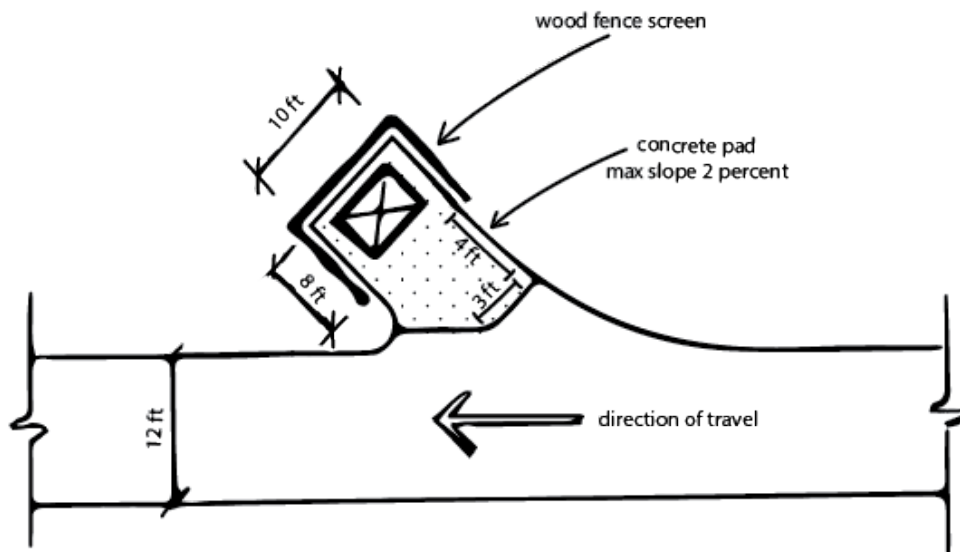

Figure 3.93 Accessible dumpster with dimensions.

PICNIC TABLE AT CAMPSITE

Picnic tables are frequently provided as a convenience at campsites and are likely to be used if provided. Picnic tables are typically located within one campsite, along with a fire ring, tent pad, and connections to hookups (water, electrical, sewer) if they are included. Maintenance and operations are easier if the same picnic table style is used throughout the park.

Materials

Build picnic tables from durable materials, including wood, metal, concrete, or a combination of these. Ensure picnic tables are a minimum length of eight feet and should always incorporate accessibility design guidelines. Picnic tables in light color will stay cooler in sunny areas; in cooler areas, dark colored tables are preferred to avoid visual clutter.

Accessibility.

All new picnic table installations must comply with requirements for accessible seating spaces, table clearance, slope, and surface. This is true whether the table is in a campground, picnic area, or other recreation site. Picnic table accessibility is required even if the individual campsite is not specifically designated as accessible.

Provide a variety of wheelchair-seating locations at each picnic table (i.e., end, center, or side access). The number of wheelchair seating spaces that must be provided at each table is based on each 24 linear feet of usable table surface perimeter. The standard picnic table of eight feet in length should have at least one wheelchair space.

Knee space for wheelchair seating must be at least 30 inches wide, 19 inches deep, and 27 inches high, as measured from the finished ground or floor to the bottom of the tabletop measured to the lowest part of the tabletop, including any brackets, fixtures or bolts, which will impact the use of the accessible space. Toe clearance of at least nine inches above the ground or floor must extend at least an additional five inches beyond the required knee clearance. Toe clearance is required to ensure that someone in a wheelchair is able to sit close to the tabletop, regardless of the design of the picnic table. For example, if the table is constructed with one solid leg on each end, as opposed to an A-shaped frame or two individual legs on each end of the table, someone in a wheelchair will not be able to sit comfortably at the table.

In addition to providing clearance at the table, clear floor or ground space must be provided. The clear ground space must be at least 30 inches by 48 inches at each wheelchair seating space. The clear ground space must be positioned to accommodate a forward approach to the table. No exceptions to the wheelchair seating space requirements are permitted. A perimeter of clear floor space must also be provided around the usable portions of the table, measuring 48 inches in width minimum, to allow for movement around the table.

The slope of the required clear floor or ground space for wheelchair seating spaces and for table clearance may not exceed two percent in any direction. Slopes not steeper than three percent are permitted, however, where necessary for drainage on surfaces that are unpaved or not built with boards. The surface of the clear floor or ground space must be firm and stable. The type of surfacing used should be appropriate to the setting and level of development. Unpaved surfaces must be maintained so that they remain firm and stable to the maximum extent possible. This will require additional and ongoing maintenance.

Design Considerations

Campgrounds managers will need to decide if picnic tables should be anchored to the ground to prevent theft and relocation, or if the tables should be movable to accommodate shade preferences. Attaching picnic tables with a tether allows for secure anchoring while also providing flexibility to

the visitors. Allowing movement of a table, even with a tether, may negatively impact the clear accessible space surrounding the table and create a need for additional staff hours to relocate tables repeatedly.

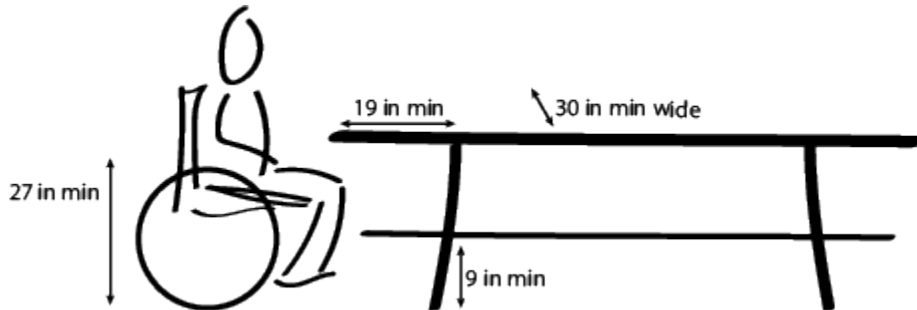

Figure 3.94 Accessible picnic table with dimensions.

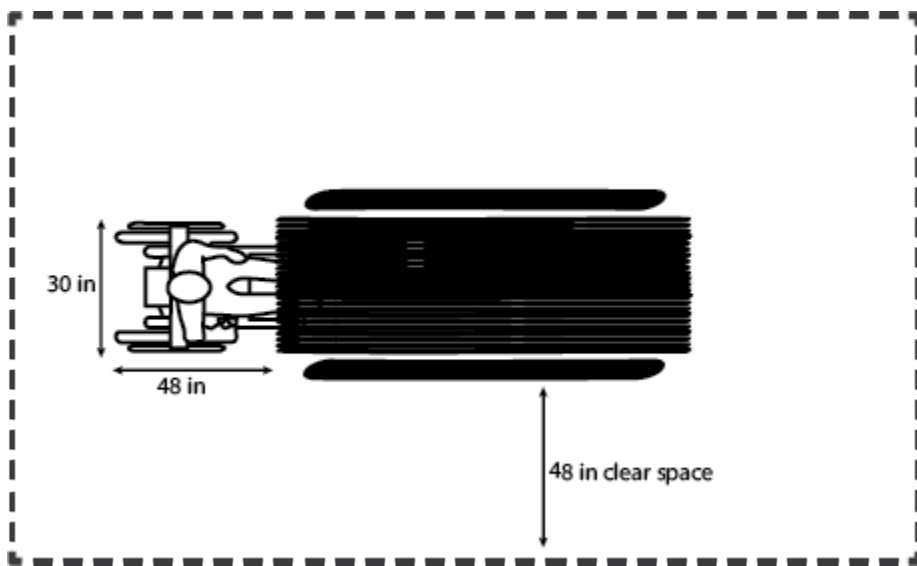

Figure 3.95 Accessible picnic table with dimensions in the plan view.

PICNIC AREAS (STAND ALONE)

Stand-alone picnic areas have been incorporated in National Park Service campgrounds since the 1920s. These areas provide a place for individuals and groups to relax and gather with family and friends in a location separate from individual campsites. The ideal picnic area is durable, requires low maintenance, and is environmentally sensitive. Pairing picnic areas with shade structures allows for visitors to enjoy the picnic sites with sun cover and protection from precipitation.

Distance and Ratios

Ensure picnic areas are accompanied by a cooking surface or grill attached to a fire ring and a toilet facility. In addition, design picnic areas close to parking, ideally within 300 feet of the parking area. Size the picnic to meet the needs of the specific campground and its anticipated level of use. This could range from a high density of 150 picnic sites per acre to a low density of 50 picnic sites per acre and is dependent on the individual campground character and amount of use.

Group Picnic Sites

Land management agencies have experienced an increase of recreation occurring in large groups. Consider whether a group picnic site would be appropriate for the campground to accommodate large groups of visitors recreating together. Group picnic sites are more formalized than stand-alone sites described above and should incorporate large covered group shelters (where feasible), large picnic tables, and large grills. If fire rings are provided, consider a larger fire ring rather than several smaller fire rings. Group sites should also provide accessible features.



Figure 3.96 Picnic pavilion at Buffalo National River, Arkansas, Buffalo Point Campground.

Accessibility for stand-alone and group picnic sites.

Wherever possible, picnic sites should exceed the minimum number of required accessible picnic tables. Having one style of picnic table reduces maintenance; it also reduces management needs by preventing the need to move visitors from accessible picnic tables when visitors with disabilities need access. Many visitors prefer using accessible picnic tables with extended tops because this is an easy location to place coolers and picnic supplies. Make sure to disperse accessible picnic sites throughout the area at several locations to allow individual choice. This includes providing picnic sites under trees or shade shelters, in sun, near water, with preferred sight lines, etc. Locate the accessible sites near other accessible features in the area, including parking spaces (within 150 feet), comfort stations, water hydrants, etc. However, do not limit accessible picnic sites to only those closest to parking and comfort stations; some people with disabilities want the privacy afforded by locations farther from the parking lot. Distances can be from 200 to 500 feet from parking lot to picnic tables overall. ([Distance chart link](#)). Accessible picnic sites should include all features offered within other picnic sites.

For picnic areas with two or fewer picnic sites, ensure each site is accessible. For picnic areas with more than two picnic sites, at least 20 percent of sites should be accessible, and these sites should be dispersed throughout the area. Accessibility requirements must be met for all altered sites.

For larger tables, one wheelchair seating space is required for each 24 linear feet of usable space around the perimeter of the table. Practically speaking, tables up to 9 feet (2.74 meters) long usually require one space. Tables between 10 feet (3.05 meters) and 20 feet (6 meters) long usually require two wheelchair spaces, and so on for longer tables, such as four spaces for tables that are 40 feet (12 meters) long.

Provide a variety of wheelchair-seating locations at each accessible picnic table (e.g., end, center, or side access). One wheelchair seating space must be provided for each 24 linear feet of usable table surface perimeter. All accessible picnic tables require a minimum of 36 inches clear space on all usable sides (measured from the back edge of the bench). Each wheelchair space needs to be 30 inches wide by 48 inches deep minimum and positioned for forward approach and meet knee and toe clearance requirements. Ensure each accessible picnic table is fixed to the ground to keep it from being moved into an inaccessible location. If a center-cut or side-cut table is used, paint a warning on the ground or around the edges of the cut surface in a color that sharply contrasts with the surrounding surface to alert persons with visual impairments that there is no bench seating in this location.

All clear maneuvering spaces should meet standards and guidelines for accessibility. The surface of the clear space must be firm and stable (i.e., resists deformation by indentation). If the surface is concrete, asphalt, or boards, ensure the clear ground space slope is no more than two percent. If the surface is other than concrete, asphalt, or boards, then the clear ground space slope can increase up to three percent in any direction if needed for drainage.



Figure 3.97 Platte River Campground at Sleeping Bear Dunes provided an accessible group campsite with room to spare. A person with disabilities can sit any table and not feel excluded.

FIRE PITS AND GRILLS

Fire pits and grills increase the opportunity for visitors to cook food safely, increase protection from fire, and allow visitors to enjoy campfires in a controlled way.

Specifications

Provide a clear floor or ground space around all usable sides of a fire ring, grill, fireplace, or wood stove so that someone isn't forced to get too close to the heat or fire and risk getting burned. The clear space must extend at least 48 inches out from the feature and be at least 48 inches wide. In many cases, a 48-inch-wide ring of clear space must be provided all around because all sides are usable.

Ensure the fire-building surface within a fire ring is a minimum of nine inches above the finished floor or ground surface. Make sure the cooking surface is between 15 and 34 inches high. Ensure the width of the raised edge or wall around the fire is less than ten inches wide.

The slope of the clear floor or ground space must not exceed two percent in any direction. When the surface is unpaved or not built with boards, a slope of three percent or less is allowed where necessary for drainage. The surface of the clear floor or ground space must be firm and stable, and the surface material used should be appropriate to the setting and level of development.

Accessibility.

Controls and operating mechanisms for fire rings, grills, fireplaces, and wood stoves must meet the requirements for reach ranges and operability specified in [ABAAS 308](#) and [ABAAS 309](#). Ensure that each cooking surface, grill, and pedestal grill meets the requirements for cooking surface height, clear floor or ground space, slope, and surface. The height requirements are based on the height for countertops and the minimum low forward reach range in [ABAAS 1011.5.2](#). Ensure the height of the cooking surface is 15 inches to 34 inches above the finished floor or ground surface. All fire rings should have a 48-inch by 48-inch minimum clear maneuvering space around all usable sides. To the greatest extent possible, ensure all fire rings are accessible. Consider the relationship between the grill location and picnic table so there is easy maneuverability for wheelchair users while cooking.

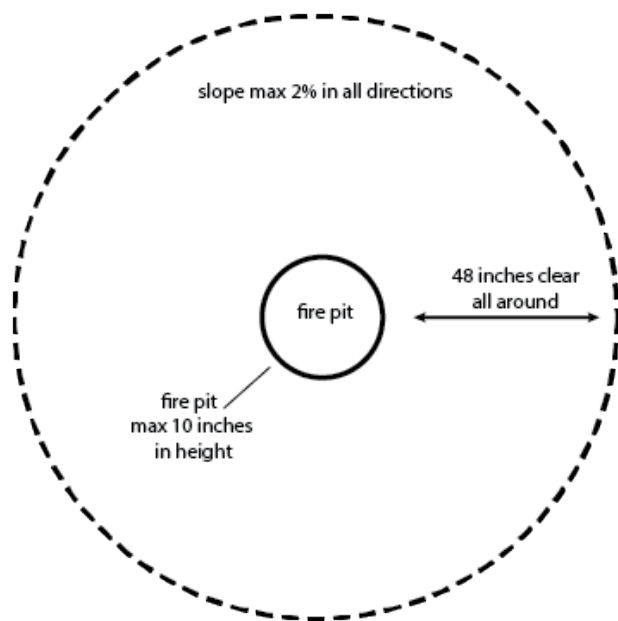

Figure 3.98 Fire pit with clear space, plan view.

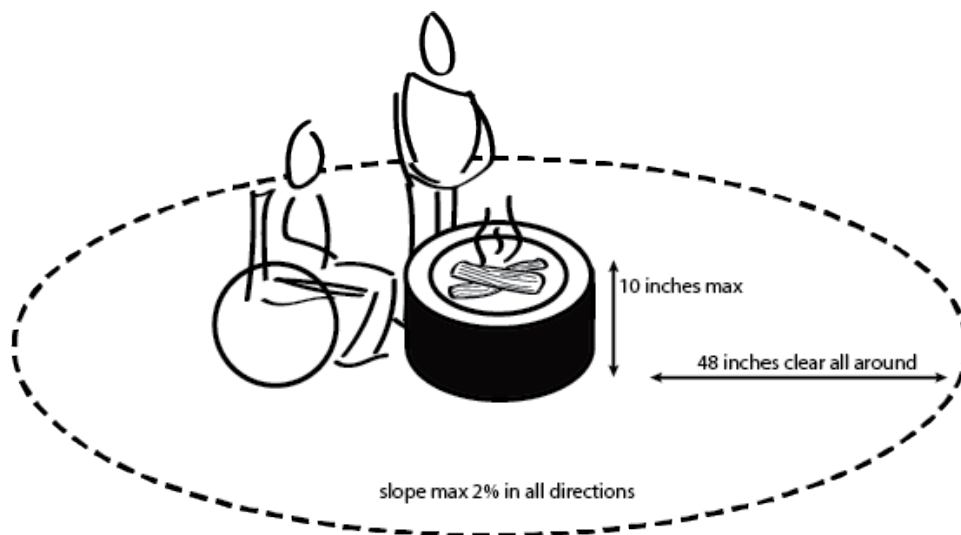

Figure 3.99 Sketch of fire pit with clear space.



Figure 3.100 Woman in wheelchair using pedestal grill at campground in Coconino National Forest.



Figure 3.101 Firepit at Mather campground, Grand Canyon National Park.

Design Considerations

Consider the placement of tent pads and location of shrubs, brush, and trees when siting fire ring location to reduce potential fire hazards. Place fire sites downwind from picnic tables (based on prevailing wind direction) to minimize fire hazards and smoke in the picnic area. Ensure the ground surface under the fire ring and extending two inches beyond the edge of the fire ring is of compacted road base or gravel. Use fire-resistant materials that are historically and architecturally consistent with the setting, as well as construction techniques, such as enclosing overhangs and eaves, to

minimize the risk of fire damage. Avoid the use of non-fireproof concrete due to the danger of extremely hot concrete exploding. Construct and maintain a firebreak around facilities to reduce potential wildfire impacts. Consult with wildland fire specialists to determine if there are any local requirements that should be considered in the design of fire pits and grills. Where grills are provided, consider providing a metal trash container for spent charcoal to reduce fire danger.

BEAR BOXES / FOOD LOCKERS

Typically used in bear country, bear boxes, also known as food storage lockers, are important amenities to protect visitors and wildlife. Bears, coyotes, and racoons can break into a wide variety of trash containers. Bears have been documented breaking into vehicles, including car trunks, to access stored food. Once a bear has discovered a campground is a reliable food source, break-ins may become habitual and force the need to relocate or destroy a bear. Bear boxes should be used to store all food and drinks, toiletries and scented items, ice coolers, dishes, and undisposed trash and recycling. Campgrounds in bear country should provide at least one metal food lockers for each campsite. Group campsites should supply multiple food lockers or a larger secure shed to match the occupancy of the group site. Mechanisms on animal proof containers do not meet the accessibility requirement for pounds of force required and are exempt. However, access to each food locker is still required to meet guidelines for clear ground space and firm and stable surfaces.



Figure 3.102 Bear box in an accessible campsite in Grand Teton National Park, Jenny Lake Campground.



Figure 3.103 Cook shelter in Kenai Fjords National Park, Exit Glacier Campground.

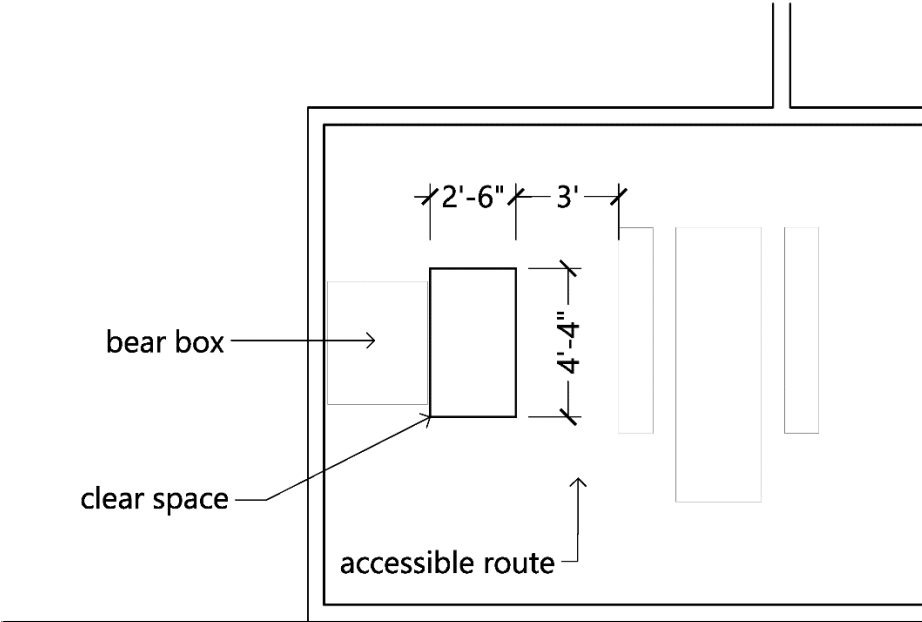

Figure 3.104 Bear box with accessible route and clear space.

HAMMOCK HANGERS

Hammocks are an emerging use in campgrounds that has increased exponentially in popularity over the last five years. Providing hammock stands or hangers increases opportunities for the visitor while protecting park resources. Hammock hangers can prevent tree damage caused by hammock hanging and facilitate the ease of visitors hanging hammocks for relaxation. For some visitors, hammocks are preferred over tents for sleeping. A simple hammock pipe stand is low cost, sturdy, and provides ample room for hanging hammocks at campsites. Multiple hammocks can be hung using one central post and concentric posts around the hammocks to accommodate group hammock setups as well. As a new use, no standard accessibility guidelines exist specifically for hammock hangers. However, basic accessibility regulations include provision of an accessible route, firm and stable surfaces, and appropriate reach ranges for all amenities.

LIGHT POSTS / LANTERN HANGERS

Light posts or lantern hangers are a convenient way to provide light and protect trees from damage. Visitors provide their own hanging lights and can use a hanger if provided. Without a hanger, visitors may use nearby trees and potentially cause resource damage. The recommended distance from the ground to the lantern hanger is about 80 inches; a lower hook should also be installed to ensure the hanger is useable to those sitting in a wheelchair.



Figure 3.105 Lantern hanger at Black Canyon Campsite, Santa Fe National Forest.

EXPANDED CAMPGROUND SERVICES

Showers

Showers can be provided as an addition to the basic comfort station building. Ensure the shower rooms are separate from the rest of the building, with entries located on the exterior of the building. The building should feature energy-efficient lighting, and the water should be heated by solar energy if possible. A common modern design is for a shower house to have individual family bathrooms that include toilet, sink and shower. This design is used at Price Park in Blue Ridge National Park.

Distance and Ratios

In a campground design, ensure there is a minimum of one shower per 20 to 25 people or four to five campsites, understanding that most bathing occurs in bursts in the morning or evening. The recommended distance from the shower to campsite is 250 to 500 feet from the farthest accessible campsite. An inclusive campground aims to provide all campsites to within roughly the distance, realizing that this is not always achievable. Showers may not be distributed throughout the campground like comfort stations. Regardless, parking should be provided at a shower facility. The recommended distance from the shower to parking is 35 feet; allow for one parking space for every five shower stalls plus accessible spaces per [ABAAS F208](#) (see [Parking Table](#) for more information).

Design Considerations

See [Water Supplies](#) for anticipated water usage.

A quality shower facility will include sufficient hot water, odor-free private shower stalls, and dressing areas with adequate sloping floors to prevent any water collection. Hooks for hanging clothing, adequate lighting, and clean non-slip floors should be provided. For larger shower facilities, especially if combined with a laundry facility, a boiler system with hot water holding tanks may be the most efficient means of providing hot water to many users at the same time.

Building design. Shower facilities can be designed with either gendered or gender-neutral shower and dressing rooms. For gendered showers, include a communal dressing area, which can help reduce space requirements. The gender-neutral design allows for private use by either gender, and generally better accommodates families and those requiring assisted care. Gender neutral shower facilities also provide a constant supply of showers for the public (instead of one gendered facility reaching capacity while the other remains available), provide more efficient maintenance (not requiring a closure of an entire male or female shower at once), and improve administrative controls by allowing closure of individual showers for emergency repairs.

Maintenance / infrastructure considerations. To prevent mold and mildew from accumulating in shower facilities, proper ventilation is key. Mechanical ventilators or fans are the most effective method of circulating air, and passive venting with vaulted ceilings, screened windows or vents installed near the ceiling can be similarly effective. To take advantage of prevailing winds, ensure the upper building vents face the lee side of the prevailing winds and the floor vents are installed on the windward side. The result is a constant movement of air, a "push- pull" effect. The prevailing winds will push air into the building through the windward facing floor vents and pull moist air out the leeward facing ceiling vents. To prevent mold and mildew on the floors, install curved floor corners to help ease cleaning.

Install the soap dish against a smooth vertical surface, free of tile seams or crevices where dissolved soap residue draining from the dish can accumulate. Mount the dish closer to the floor (about 40 inches above the floor) and away from direct spray of the shower to reduce the need for frequent cleaning and to accommodate people with disabilities. Provide service faucets to assist maintenance personnel in cleaning each shower compartment. Ensure this faucet is concealed inside a recessed wall enclosure to reduce vandalism and accidental injuries to the bather. Include a temperature gauge to ease maintenance operations as well.

Plumbing chase / storage area. In cool climates, the plumbing system must be winterized. Depending on location, winterization can consist of heating the plumbing or completely draining the system. The latter method is most common but requires a central fall point for draining the water out of fixtures, water heaters, and service lines. Design the plumbing chase or "pipe chase" to be wider than four feet to allow for the compartment to double as a storage area for cleaning supplies, equipment, and water heaters. New shower structures often include a utility chase in the middle of the structure to allow easy maintenance access.

Surface materials. The following wall surface materials are both durable and easy to clean such as: porcelain enamel on steel, reinforced fiberglass, glazed masonry block, and ceramic tiles. The following floor surface materials are durable, easy to clean, and slip resistant: unglazed quarry tile, and quartz broadcast epoxy-resin topping. The condition of the existing concrete floor surface or substrate will determine what surface coverings (i.e., tiles, resin coatings, or toppings) are feasible. Irregularity in the substrate is difficult to correct with tile flooring or resin coatings. When using tiles for the floor surface, small one-inch square tiles are more slip resistant than larger tiles. Be sure to use a surface sealant for all tiling to help reduce trapping dirt and soap. The slope for flooring must be no greater than two percent.

Dressing area. Dressing areas need to be clean with a dry floor surface. Provide separation from the shower to the dressing area to decrease shower water from spilling into the dressing area. The dressing area floor should be sloped two percent. Consider integrating the following items into a dressing area:

- Small cubby or locker for personal belongings
- Sturdy shelf
- Waste receptacle
- Numerous sturdy clothing and bag hooks (ensure both high and low heights for accessibility)
- Benches (plastic top with steel support brackets)
- Mirror

Construct all shelves, waste receptacles and other protruding fixtures from noncorrosive material and have rounded corners/edges to reduce the risk of serious injuries during an accidental slip or fall. In addition to benches for changing indoors, provide waiting benches in a sheltered outdoor space at the shower facility. The benches provide the waiting bather with basic sitting accommodations and assists in establishing a system of self-regulating use at the facility.

Shower plumbing systems. The three principal components common to all shower plumbing systems include: shower control valve, shower head, and water heater. Shower controls can either be mounted to the wall or used with column units and should be simple to use. Column type shower units are best suited for high use areas, although they are less private than single stall showers.

Column showers can incorporate partitions or curtains to add more privacy. For wall-mounted fixtures, ensure the shower controls and plumbing pipes are recessed in the wall or concealed behind an enclosure or panel to prevent vandalism and safety concerns.

Shower control valves. Control fixtures for shower facilities can either be manually controlled (allowing temperature and volume to be controlled by the user) or automatically controlled (temperature, volume, and/or duration preset for the user). Manual controls are the simplest to operate and most familiar to the user. Manual controls provide the greatest user satisfaction but promote little if any water/energy conservation. Automatic controls provide the user with little or no means of customizing the shower to his/her comfort level, but they can also be preset to meet the needs of a wide range of user preferences. Automatic controls help reduce operating costs, including water consumption, waste treatment, and heating fuel. Comfortable water temperatures will range from about 90° F to 95° F. For context, damage to skin occurs at 110° F to 115° F. Showers should have scald prevention.

There are three types of valves typically used in showers: flush, metered/timed, and thermostatic. Flush valves are very durable and have a lever or push button actuator to trigger the mechanically metered flush valve. Metered or timed valves, on the other hand, are designed to actuate mechanically, pneumatically, or electronically and then self-close after a set period or cycle. The valves are manufactured with fixed cycles or with field adjustable cycles, ranging from 5 to 60 seconds. Metered valves are generally smaller than flush valves, allowing installation in confined plumbing chases. Lastly, thermostatic mixer valves have an automatic control fixture with a metered "on-off" valve. Thermostatic valves do not have the capability of mixing hot and cold water to a usable temperature, so a temperature regulating device or "thermostatic mixer" valve must be installed between the water supply lines and automatic control valve. The mixer valve regulates the water temperature for the user at a set level selected by the facilities manager and serves as an anti-scald valve to protect the user during use. The thermostatic mixer senses any sudden change in water supply pressure or temperature (i.e., a drop in cold-water pressure due to someone flushing adjacent toilets on the same water supply line) and responds by instantaneously adjusting the amount of hot water delivered to the automatic control valve. Comfortable water temperatures will range from about 90° F to 95° F. For context, damage to skin occurs at 110° F to 115° F. Showers should have scald prevention.

There are three types of valves typically used in showers: flush, metered/timed, and thermostatic. Flush valves are very durable and have a lever or push button actuator to trigger the mechanically metered flush valve. Metered or timed valves, on the other hand, are designed to actuate mechanically, pneumatically, or electronically and then self-close after a set period or cycle. The valves are manufactured with fixed cycles or with field adjustable cycles. Metered valves are generally smaller than flush valves, allowing installation in confined plumbing chases. Lastly, thermostatic mixer valves have an automatic control fixture with a metered "on-off" valve. Thermostatic valves do not have the capability of mixing hot and cold water to a usable temperature, so a temperature regulating device or "thermostatic mixer" valve must be installed between the water supply lines and automatic control valve. The mixer valve regulates the water temperature for the user at a set level selected by the facilities manager and serves as an anti-scald valve to protect the user during use. The thermostatic mixer senses any sudden change in water supply pressure or temperature (i.e., a drop in cold-water pressure due to someone flushing adjacent toilets on the same water supply line) and responds by instantaneously adjusting the amount of hot water delivered to the automatic control valve.

Shower heads. The conventional household shower head passes water at a rate of four to eight gallons per minute (gpm). Water saver or "low-volume" shower heads restrict water flows down to 1.3 gpm. Though water saving shower heads reduce consumption, they also result in a more noticeable effect of hot water scorching when the cold-water pressure suddenly drops (from a toilet flushing, for example). A thermostatic mixer valve helps reduce this issue with water saving shower heads. Shower heads with fixed direction and fixed spray pattern provide the least amount of user adjustment and results in the least maintenance. Self-cleaning shower heads can also help reduce the accumulation of sediment and minerals and should be considered in areas with high mineral content.

Water heaters. Depending on energy resources available (i.e., solar, gas (natural or propane), or electricity), the water heater can influence annual operating cost for the entire system. Electric water heaters are high energy consumers, usually requiring a 220-volt electrical source and have a slow recovery (time required to heat or recharge the tank to full hot water capacity at the selected temperature setting). The typical tank capacity of electric water heaters required for public showers range from 80 to 120 gallons, depending on use. By comparison, the typical capacity of water heater tanks for the family home is 40 to 82 gallons.

Gas (propane or natural) water heaters can be operated economically in areas with ample supply of these energy resources. Gas heaters have faster rapid recovery than electric water heaters. Unlike electric heaters, gas heaters produce exhaust that must be insulated and vented out of the building. In remote locations, propane storage tanks can present a problem due to vandalism, leaks, etc. If a gas water heater is being considered, ensure provisions for safeguarding against these problems are considered beforehand.

Instantaneous water heaters are also known as "tankless," "inline," or "on demand" water heaters, were developed to conserve energy by heating water only during the period of demand. This is accomplished by passing the water through heated coils prior to the delivery to the user control valves. The water temperature can be pre-set at the heater to prevent scalding, eliminating the need for thermostatic mixer valves. Instantaneous water heaters can be installed in groups to serve several showers simultaneously and can be powered by natural gas, propane, or electricity.

Solar water heaters can be used where sunlight is readily available, as an inexpensive source of hot water. Solar water heating can be unpredictably reliable due to changes in weather and should therefore be used as a supplement to conventional gas or electric heating systems.

Accessibility.

All newly constructed and reconstructed shower facilities must be made accessible to people with disabilities. In a new shower facility, all shower stalls must be accessible to meet code requirements. The design must include the following hardware: waterproof shower seat, grab bars, and a lever or push-button type control fixture. The shower head should be hand-held or dual fixed mounted to allow coverage over the entire body. In addition, five-foot-wide accessible concrete walks need to connect the front covered entry to the shower entrances. The interior of the shower areas should meet accessibility standards, including dimensions of the room (transfer shower or roll-in shower), and placement of the transfer seat, clothes hooks, and dressing room bench. Showers that are separate from the rest of the building and located on the sides of the building should meet accessibility standards. Reference ABAAS F213.2.1, F213.3.6, F213.3.7, and 608.

DUMP STATIONS

Dump stations should be incorporated into campgrounds that serve RVs to provide a way for visitors to empty RV sanitary sewer lines. Design and install dump stations at developed recreation sites where commercial RV sanitary stations are not available within a reasonable driving distance and on-site sewer or septic utilities are present. A dump station should include a storage tank clean-out and potable water fill water towers, approved fixtures, and appropriate use of backflow devices.

Distances and Ratios

An RV unit's sanitary sewer service connection is typically on the rear 1/3 of the unit on the driver's side, and RVs can be up to 40 ft in length plus a tow vehicle. Since the campsite's service connection is flush with grade and will not inhibit movement of RV sliders and access hatches and because RVs are typically equipped with only 10 feet of hose for connection to a sewer service, it is proposed to place the service connection approximately four feet from the parking pad edge and 20 feet from the rear of the pad (for drive through service, the 20 foot dimension is not applicable).

In most designs, the station should accommodate the concurrent servicing of two vehicles. The additional accommodation will provide a back-up, in the event one service unit must be closed for maintenance or unplanned repairs. A pull-through service station accommodating two vehicles should be 100 feet in length. While the first station is approximately 20 feet from one end of a drive-through station, the second should be nearly centered between the front and back of the pad. Service line lengths vary from zero to 80 feet, based on the campsite. A standard length of 10 feet per site is assumed for these calculations. To prevent contamination, the recommended site distance between potable and non-potable faucets at dump stations is 40 to 60 feet. Potable and non-potable should be clearly labeled. Non-potable water is useful for cleaning up after servicing the vehicle.

Accessibility.

Because RV dump stations are accessed by vehicle, an outdoor recreation access route (ORAR) is not required to connect to RV dump stations. An accessible vehicle pull-up space is required. An accessible vehicle pull-up space must be a minimum of 20 feet wide and contain specific clear distances for utility and sewage lines as outline here: [ORAR](#)

Specifications applicable to mechanical controls and surface grades must be applied. Ensure that all devices at the dump station incorporate controls without the need for excessive grasping or twisting and accessible slopes and surfaces to approach dump stations.

Reference ABAAS F244.4, F244.5.2, 1011 and 1012.



Figure 3.106 Platte River campground dump station includes an accessible RV parking lane with island access aisle to approach station components (Sleeping Bear Dunes National Lakeshore).

Instructions

Dumping Station

Dump Station Fee - \$5.00
Free if Camping in Park
Please Pay at Store



1. Connect
your hose to trailer
holding tank



2. Insert
hose end securely
into drain, holding
cover open with
foot... open trailer
drain valve



3. Wash
any spillage into
the drain using
water provided

DANGER

Water is Unsafe to
Drink or Use for
Domestic Purposes

NOTICE

Septic Tank Waste
and Gray Water ONLY

Dumping of Toxic
Chemicals is Prohibited

Figure 3.107 Example sign with dump station instructions.

LAUNDRY

Laundry buildings are designed for recreation sites with high visitation where the average length of stay is several days. Where appropriate, laundry facilities can be provided as an addition to the basic comfort station building or attached to a camp store. Laundry should be located at the rear of the building and accessed by a separate covered entry. Laundry services may also be needed for volunteer campground hosts. Machines are typically coin or credit card operated. In addition to washing machines and dryers, provide a table for staging and folding. If the facility is not attached to a camp store, provide a coin or credit card operated vending machine with detergent and other laundry supplies.



Figure 3.108 Grand Canyon National Park, Arizona, Mather Campground laundry facility.

Accessibility.

There should be a clear space in front of the machines that is a minimum of 30 inches by 48 inches and positioned for a parallel approach. Operable parts, including doors, lint screens, and detergent and bleach compartments need to be within reach ranges prescribed in the standards. Controls and operating mechanisms at laundry facilities should be operable with one hand and should not require tight grasping, pinching, or twisting of the wrist. The force required to activate operable parts should be five pounds maximum. Top loading machines should have the door to the laundry compartment located 36 inches maximum above the floor. Front-loading machines should have the bottom of the opening to the laundry compartment located 15 inches minimum and 36 inches maximum above the finish floor. Folding tables, vending machines, and other public use features in the laundry facility should be located on an accessible route, have the necessary clear space, and be within reach ranges. Reference ABAAS F214 and 611 for washers and dryers.

CAR CHARGING STATIONS

Providing car charging at a campground helps accommodate those who drive electric-powered vehicles, especially in remote areas far away from urban centers. Car charging may be provided at specific campsites or may be provided in a central car charging area. Car charging is typically provided by concession or by agreement. Be aware that it is illegal in some states for the federal government to resell electricity; this was a federal law that changed in 2019 to be individually state mandated. Depending on the state, a park may or may not be able to collect a fee for car charging. In some locations it is legal for a concessioner to provide this service, but not for a federal government to do so.

Configurations and requirements for car charging stations go beyond the scope of this guide. Additional resources may be found:

- [Electric Vehicle Charging Station Installation Guidelines](#)
- [Siting and Design Guidelines and Electric Vehicle Supply Equipment](#)



Figure 3.109 Example of Electrical vehicle charger installed at Catocin Mountain Park, Maryland. Charger installation requires a transformer that can accommodate the charging stations. This may require a new transformer, new panel, new disconnect switch, meters, bollards, electric vehicle parking signs and striping, electrical conduits, and the charging stations themselves.

CHAPTER FOUR: OPERATIONS AND MAINTENANCE

Note for reviewers

Operations and maintenance tips were integrated into other sections using call out boxes. Good design ensures ease of maintenance and operations. It is important to engage facility and operation staff during planning and design. This is critical to understanding issues early in the design process and ensure challenges will be resolved through good design and construction practices.

This section of the document will include high-level information (not detailed processes) which would make the document too long. This section will also touch on customer service best practices. A discussion of staffing considerations will potentially be added.

This page intentionally left blank.

APPENDIXES

This page intentionally left blank.

APPENDIX A: REFERENCES

- Brown, D.
1996 Park design guidelines & data. Province of British Columbia. Ministry of Environment Lands and Parks.
- Carr, Ethan
2007 Mission 66. Amherst: University of Massachusetts.
- Collins, B.
2010 Bureau of Land Management (BLM). Guidelines for a quality-built environment. First edition.
- Cordell, H., James, G.
1973 Visitor Preferences for Certain Physical Characteristics of Developed Campsites. School of Forest Resources Department of Recreation Resources Administration North Carolina State University at Raleigh.
- Davis, Timothy
2016 National Park Roads: A Legacy in the American Landscape. Canada: University of Virginia Press.
- Dolan, Susan
2020 Personal Communication with Julie McGilvray.
- Duncan, Dayton
2009 The National Parks: America's Best Idea. New York: Alfred Knopf.
- Foulds, Eliot
1996 "Cultural Landscape Report for Blackwoods and Seawall Campgrounds." Report prepared for the Olmsted Landscape Preservation.
- Good, Albert
1990 Patterns from the Golden Age of Rustic Design. Maryland: Roberts Rinehart Publishers.
- Grasslands. US Department of Agriculture: FS-710.
- Hansen, D.
2015 Integrating Hammocks into Parks, Designated Campsites, and Jamborees. The Ultimate Hang. <https://theultimatehang.com/2015/06/07/integrating-hammocks-into-parks-designated-campsites-and-jamborees/>
- Hoshide, Gary
1991 United States Department of Agriculture, United States Forest Service, Technology & Development Program. Utility Hookups for Campgrounds. A general guide for designing and maintaining shower, RV sanitary dump stations, and RV electrical service equipment.

- Hopper, Leonard
 2007 Landscape Architectural Graphic Standards. New Jersey: John Wiley & Sons.
 KOA. 2019. North American Camping Report, 5-year trends.
- Kuhn, T., and Beckley, B.
 2005 New accessible handpump for campgrounds. Tech Tip 0571–2311P–MTDC.
 Missoula, MT: U.S. Department of Agriculture, Forest Service, Missoula Technology and
 Development Center.
- McClelland, Linda Flint
 1998 Building the National Parks. Baltimore and London: The Johns Hopkins University
 Press.
- McGilvray, Julie
 2017 “Badlands Design Guidelines.” Report prepared for the National Park Service in
 collaboration with the Midwest Regional Office and Badlands National Park, The
 University of Texas Austin School of Architecture, and the Lady Bird Johnson
 Wildflower Center.
- Model T Ford Forum
 2016 Old Photo – Camping at Yellowstone National Park circa 1923.
<http://www.mtfca.com/discus/messages/599638/607056.html?1453591940>
- Musselwhite, Phil
 2009 “National Park Service Identity and Signage.” <https://segd.org/national-park-service-identity-and-signage>.
- Muskingum Watershed Conservancy District Design Guidelines (2014).
- Parks Canada
 2007 Exterior Signage: Standards and Guidelines.
- PBS
 2009 National Parks History. WETA, Washington, DC and The National Parks Film
 Project, LLC. <http://www.pbs.org/nationalparks/history/ep4/>
- Treib, Marc
 1993 “Axioms for a Modern Landscape Architecture,” *Modern Landscape Architecture: A
 Critical Review*, Marc Treib, editor (Cambridge, Massachusetts: MIT Press, 1993),
 53-55.
- Unknown
 2020 “Tuolumne Meadows Campground: Yosemite National Park, Cultural Landscape
 Report.” Report prepared for the National Park Service under contract with Mundus
 Bishop, Anderson Hallas, Otak.

US Department of Agriculture, Forest Service (USFS).

- 1991 Cook, B. USFS Technology and Development Program. In-Depth Design and Maintenance Manual for Vault Toilets. Technology & Development Center San Dimas, California.
- 1998 Erlenbach, D., Lachapelle, P. Forest Service Technology and Development Center San Dimas, California. Planning Guide for On-Site Greywater/Wastewater Disposal Systems for Recreational and Administrative Sites Part II.
- 2001 The Built Environment Image Guide: For the National Forests and US Department of Agriculture, Forest Service.
- 2002 Forest Service San Dimas Technology and Development Center. Scenic Byways: a design guide for roadside improvements.
- 2008 Forest Service Handbook: FSH2309.18 Trails Management Handbook.
- 2013 "Sign and Poster Guidelines for the Forest Service." EM 7100-15.
http://www.fs.usda.gov/Internet/FSE_DOCUMENTS/stelprd3810021.pdf
<https://segd.org/national-park-service-identity-and-signage>
- 2018 FSH 2309.13 Recreation Site Handbook. Chapter 10, Planning and Design of Developed Recreation Sites and Facilities.

US Department of the Army. US Army Corps of Engineers.

- 2004 Recreation Facility and Customer Service Standards. US Army Corps of Engineers: EM 1110-1-400.
- 2004 Design of Recreation Areas and Facilities – Access and Circulation. US Army Corps of Engineers: EM 1110-1-410

US Department of the Interior. Bureau of Reclamation

- 2013 [Recreation Facility Design Guidelines.](#)

US Department of the Interior, National Park Service (NPS)

- 1957-1966 Walmsley, Thomas. Index Subjects Relating to interpretation in the library of the Park Practice Program.
- 1959 Campground Study: A report to the Committee to study camping Policy and Standards. Region Four.
- 1967 A sense of place : design guidelines for Yosemite National Park.
- 1984 Park Road Standards.
- 1986 Rehabilitation of Valley Campgrounds, Lower/Upper River C.G. at Yosemite National Park.
- 2006 Management Policies.
- 2010 Rocky Mountain National Park Design Guidelines.
- 2012 Rocky Mountain National Park. Vintage Camping.
https://www.nps.gov/romo/vintage_camping.htm
- 2014 National Park Service Sign Program: Standard Motorist Guidance Details. NPS Sign Program, Harpers Ferry Center.
- 2018 National Park Service Active Transportation Guidebook: A Resource on Supporting Walking and Bicycling for National Parks and their Partners.
- 2019 O’Keefe. River Access Planning Guide: A Decision-Making Framework for Enhancing River Access.

US Department of Transportation

2007 Designing Camp and Picnic Units. Equestrian Design Guidebook for Trails, Trailheads, and Campgrounds. Chapter 9.

https://www.fhwa.dot.gov/environment/recreational_trails/publications/fs_publications/07232816/toc.cfm

2009 Federal Highway Administration, Manual of Uniform Traffic Control Devices: for Streets and Highways. US Department of Transportation.

2012 USDA & USDOT. Accessibility Guidebook for Outdoor Recreation and Trails

Wilder

2010 Campgrounds – The Basics of Design. SunCam Online.

Young, Terrance

2017 Heading Out: A History of American Camping. Ithaca and London: Cornell University Press.

APPENDIX B: HISTORICAL CAMPGROUND TIMELINE

- 1841: A. J. Downing writes “Treatise on the Theory and Practice of Landscape Gardening” – influenced by English garden design of the 18th and 19th century and adapted these to the American landscape – fostering a strong awareness and appreciation of the native landscape of the sublime and picturesque.
- 1858: Olmsted and Vaux – submit winning design for New York’s Central Park – marrying the picturesque with the naturalistic of the pleasuring ground in park design following Downing’s influence and setting the stage for early park design of the twentieth century. The park is more naturalistic than gardenlike.
- 1872: Yellowstone National Park established and envisioned as “a public park or pleasuring-ground for the benefit and enjoyment of the people.”
- 1916: Frederick Law Olmsted Jr. drafts the wording to the NPS Organic Act.
- 1914: Secretary of the Interior appointed Mark Daniels to the newly created position of superintendent to Yosemite and as landscape engineer for national parks. His efforts establish a design approach that is “in light of a careful study of the best arrangement of the buildings and for picturesqueness.”
- 1915: Stephen Mather, the assistant to the Secretary of the Interior, assumes leadership of the national parks.
- 1915: Mark Daniels states that park development should be three-tiered for accommodation with a call for permanent camps with access to food (dining establishments) and for camps in tent where visitors could prepare their own food with food available from a camp store, presented at the National Park Conference in San Francisco.
- 1916: Stephen Mather writes “Progress in the Development of the National Parks” in which is set forth his vision for the national parks comprehensively and as a system. To this accessibility was key – by rail or roadway.
- 1916: Stephen Mather envisions a National Park-to-Park highway Association connecting western parks as visitation increases dramatically (see 1914 to 1917 numbers in text). Free Automobile camps open in each park with services such as water, cooking grates, and toilet facilities. These are created in cleared areas with access to nearby supplies and fuel. (McClelland 1998)
- 1916: American Society of Landscape Architects (ASLA) holds conference devoted to the subject of national parks and the bills pending before congress to create the National Park Service.
- 1917: National Park Service takes administrative control of the existing national parks. There are 17 national parks and 22 monuments.
- 1918: Secretary of the Interior Franklin Lane establishes a policy for landscape preservation and harmonization to guide all park development and use.
- 1918: Secretary of the Interior Franklin Lane creates a statement of policy for the National Park Service. In this, he creates three fundamental principles supporting the 1916 Organic Act. From this, focus on accommodations should serve various classes of visitors from low-priced camps to high-end hotels. This included, as funds allowed, the National Park Service would create and maintain a system of free campsites. These would be in cleared areas with water and sanitary service. (McClelland 1998, p 135)
- 1918: Mather appoints Charles P. Punchard Jr. to the role of first landscape engineer to the National Park Service. In Landscape Architecture Magazine, Punchard describes his work as one of “control” balancing preservation with improvements for the comfort and

accommodation of visitors – he believed this balance could be achieved over time with careful planning (McClelland 1998, p. 137).

- 1920: Daniel Hull hired by Mather to assist Punchard as the rise for landscape architecture grew. Hull became the Senior Landscape engineer in Nov. 1920. (McClelland 1998, p. 159). He stays at the National Park Service from 1920-27 when the design office (Landscape Division) is moved to San Francisco.
- 1920: Park Superintendent Conference in Denver: the National Park Service adopts its first system of uniform signage.
- 1922: Thomas Vint is hired by Daniel Hull. Vint takes over from Hull in 1927.
- 1921: NPS Director Stephen Mather convenes the first state park conference in Des Moines Iowa – which leads to a broader scale leadership role of the National Park Service during the 1930s.
- 1924: Congress granted appropriations annually for the development of roads and trails in national parks.
- Mid-1920s: Housekeeping camps are introduced as a concept. This type of camp helps standardize cabin and other building design to be used throughout the new deal era.
- 1926: The National Park Service signs cooperative agreement with Bureau of Public Roads under which park roads attained the most up to date standards of road design (McClelland 1998, p. 196).
- 1927: Thomas Vint takes over Landscape Division from Hull. By this time, the role of the landscape engineer is focused in three ways: locating and designing park roads, designing park structures, and reviewing concessioner plans and designs. Vint was the “genius” behind his program of master planning for the National Park Service creating design standards to meet the dual mission of the National Park Service. (McClelland 1998, p. 196).
- 1927: Expansion of NPS Landscape Division – Mather creates the field headquarters in San Francisco as an office of design specialists set up to advise the director and superintendents in park design, development, and management (McClelland 1998, p. 196).
- 1928: Many rustic/naturalistic design model principles and practices (rather than prototypes and standard designs) begin to show up in contracts/plans – this distinguished the design of the National Park Service and leads to originality of ideas and diversity of expression.
- Late 1920s: Education structures such as waysides and amphitheaters emerge as designed elements in the parks (McClelland 1998, p. 249). Their designs also draw heavily from the traditions of rustic architecture and naturalistic gardening (McClelland 1998, p. 250) with origins in the 1910s and 1920s.
- 1929: By this time, Vint has transformed the landscape division into a true design office with an increased emphasis on general planning (to create a general development plan for each park) with park superintendents as clients (McClelland 1998, p. 200).
- 1930: Policy introduced prohibiting the introduction of exotic plants to parks. This was considered landscape “naturalization” and came to be known as beautification program in the 1930s and was carried forward by the Civilian Conservation Core (McClelland 1998, p. 264).
- 1931: “Camps in the Woods” is written by Augustus D. Shepard, an architect of the Read Camp. The book follows the development of the Adirondack style. It was recommended by NPS chief landscape architect Thomas Vint as a useful reference for park structure design. The National Park Service followed this format for the 1935 Albert Good’s book “park structures and facilities.”
- 1932: By this time, amphitheaters have become an important structure in campground design. Designed for evening ranger talks. Their early design was primarily based on the adaptations of Maier’s woodland theater with a semicircular design located in a forest

setting. . . radiating aisles and arcs of seating descending the slope toward the stage often with a campfire circle and a screen. During this time, other educational structures are built with campgrounds such as nature trails, lookout shelters, nature shrines, and campfire areas. (McClelland 1998, p. 254).

- 1932: E. P. Meinecke writes the “Campground Policy. The beginnings of CCC/Emergency Conservation Work coincide with the USFS introduction of a new approach to campground design called the Meinecke Plan.
- 1932: Efforts that started in the 1920s to design and schedule park construction evolved into a program of master planning, creating six-year park improvement programs. The term “master plan” is stated for the first time for the National Park Service by Horace Albright at the 12th meeting of NPS executives at Hot Springs National Park. Albright stated that the primary purpose of the landscape division was to prepare master plans for all parks in the east and west. All plans were completed for all park units by the end of 1932 (McClelland, 1998 p. 302-303). They included a park development outline, general plan, and a six-year program. Campgrounds were typically found in the “minor” development areas (McClelland 1998, p. 304). From 1932 until 1942, these plans were updated annually.
- 1933: CCC is formed as the Emergency Conservation Work agency.
- 1934: E. P. Meinecke writes *Camp Planning and Camp Reconstruction*. It is immediately adopted by the National Park Service with a revision in 1934 and becomes the basis for many innovative site plans and facilities for camping in National Park Service and state park design.
- 1934: the National Park Service produces publications on park design: *Portfolio of Comfort Stations and Privies*; *Portfolio of Park Structures* – Wirth Hired Dorothy Waugh to complete these. She is the daughter of Wirth’s teacher and mentor Franch Waugh (MA ag college). The functionality of these two publications was critical – they were created as leafed binders so new designs could be easily inserted. The idea was to get new design concepts out to the CCC as quickly as possible. These two volumes addressed many small structures located in campgrounds.
- 1934: Thomas Vint, under the new title of Chief Architect for the National Park Service moves to Washington, DC, to head the Branch of Plans and Design. C. Peterson leads the Eastern Division office out of Yorktown, and William G. Karnes led the Western Division (McClelland 1998, p. 330).
- 1935: Albert Good edits *Park Structures and Facilities* for the National Park Service. This builds upon Waugh’s portfolios of 1934 but is in a different format – it is a bound book with photographs and drawings of successful design work completed by the CCC for state, and national parks (with heavy focus on state parks)
- 1935: Frank Waugh writes *Landscape Conservation*, which gives instructions on blending the edges of lakes, ponds, and plantations through a process of studying the recreating naturalistic zones based on underlying natural systems: soil, climate, etc. Based on assistant NPS director’s Conrad Wirth’s request (Wirth is Waugh’s former student).
- 1937: CCC is now its own agency.
- 1938: *Park and Recreational Structures* (three volume set) created with models and principles for designing park structures. Also edited by Albert Good.
- 1939: Henry Hubbard publishes “Landscape Development Based on Conservation, AS Practiced in the National Park Service” in *Landscape Architecture* magazine – this article summarizes the master planning process for national parks focusing on landscape protection and harmonization.
- 1939: The National Park Service issues “Master Plans: A manual of Standard Practice for Use in the NPS” (McClelland 1998, p. 311)

- 1939: CCC is heavily scaled back and loses status as an independent agency. The National Park Service begins to pull design work into regional offices and out of individual camps to handle downsizing.
- 1941: Henry Hubbard writes article for the 1941 Yearbook: Park and Recreation Progress entitled “The Designer in National Parks” laying out the park designers’ approach and aligns this with the preservation of natural character.
- 1942: CCC is terminated by July 1, 1942. In response, with fewer designers and capability to visit parks/familiarity with park needs/resources, designers advocate for more functional design, use of modern materials, streamlined forms, and mechanized technology. (McClelland 1998, p. 452)
- 1952: Cecil Doty promoted to regional designer by Vint to allow him to focus on design (Carr 2007, p. 147). Doty becomes a critical figure in NPS design much like Maier.
- 1954: Federal Highway Act of 1954: helps parks with flood of visitors by providing three years of funding for park road development.
- 1955: Fifty million visitors visit national parks – The parks were equipped to handle half that number. Park visitors want a different experience at this time and park visitation areas are too small and in poor condition.
- 1957: Following Mission 66’s first year, 1,150 projects set as part of the initial construction program at a total of \$75 million with room for 2,300 additional visitors, 930 new, and 1,300 improved campsites (McClelland 1998, p. 469)
- 1958: Mission 66 program has completed 3,200 campsites. 1961: Thomas Vint retires.
- 1960: The National Park Service had developed 7,000 individual campsites and rehabbed another 4,000 (Carr 2007, p. 292) with hundreds of campfire circles and amphitheaters created. (Carr 2007, p. 293)
- 1963: Leopold Report – stresses importance of native flora/fauna in park units and park preservation.
- 1964: Wilderness Act.
- 1966: National Historic Preservation Act.
- 1966: NPS Wilderness Guidance – sets structure to and limits development in designated Wilderness in parks.
- 1969: National Environmental Policy Act.
- 1968: The Architectural Barriers Act (ABA) - one of the earliest measures by Congress to address access to the built environment, requiring facilities designed, built, altered, or leased with federal funds to be accessible according to established standards.
- 1973: The Rehabilitation Act of 1973, Section 504 – requires access to programs and activities that are funded by federal agencies, including provisions for effective communications and equal benefit. Later amendments strengthened requirements for access to electronic and information technology (e.g., websites and electronic interpretive media) in the Federal sector (Section 508).
- 2000: DO#42 came out and provided a comprehensive approach to providing accessibility for visitors with disabilities in programs and services.
- 2012: National Park Service formed the Accessibility Task Force to improve an organizational approach to ensuring that national parks can be enjoyed by people with disabilities.
- 2020: The National Park Service Second Century Campground Design Guide is developed.